

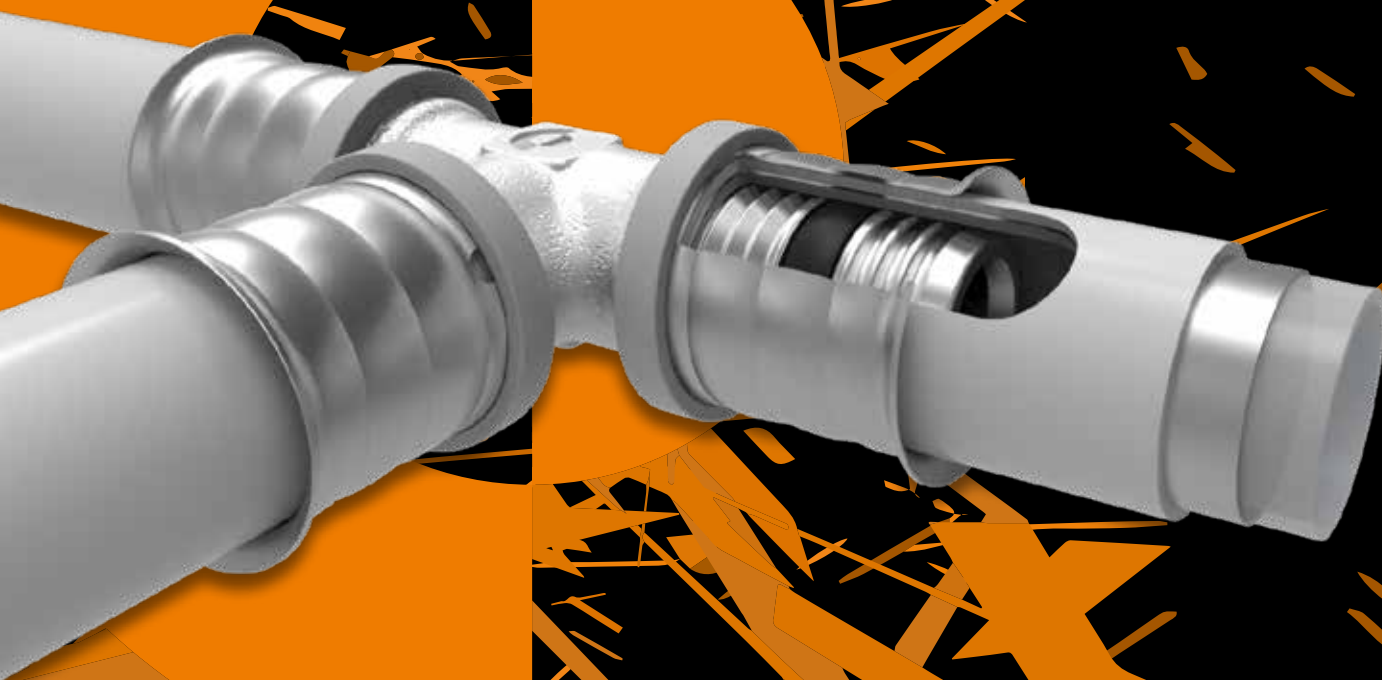

Mainpress

Pressing System



THE TECHNICAL MANUAL



www.maincor.de



info@maincor.de



[facebook.com/MaincorRohrsysteme](https://www.facebook.com/MaincorRohrsysteme)

Mainpress

Pressing System

All legal and technical information has been carefully compiled to the best of our knowledge. No liability can be accepted for any errors or omissions. This document including the contents is protected by copyright. Any use prohibited by copyright is not allowed without the permission of MAINCOR Rohrsysteme GmbH & Co. KG. All rights reserved. In particular reprinting, editing, storage and processing in electronic systems, translations and microfilms. Subject to printing errors and technical changes. All previous versions lose their validity. Please consider legal provisions, technical regulations, approvals and standards.

1. General	4
1.1 Description of the system	4
1.2 General notes	5
2. System components	6
2.1 The pipe	6
2.2 The fitting	7
2.3 Resistance coefficients in accordance with DIN 1988-300	8
3. Installation	9
3.1 Press connection	9
3.2 Bending the pipe	11
3.3 Pipe runs and fastening	12
3.4 Insulation of MAINPRESS pipe	14
3.5 Fire protection	16
3.6 Sound insulation	18
3.7 General guidelines	19
3.8 Heating with MAINPRESS	21
3.9 Sanitary with MAINPRESS	23
4. Tap water supply	25
4.1 Tap water	25
4.2 Tap water distribution	26
5. Rinsing and pressure testing	27
6. Tables	35
7. Standards	47
8. Certificates and guarantees	48

1. General

1.1 Description of the system

Area of application

The MAINPRESS system sets standards in processing and application in the area of heating and sanitation. It is ideal for quick and secure assembly; it is easy to bend but nevertheless structurally stable.

The different heating and sanitation systems for residential and office buildings must fulfil a range of different requirements. The areas of application for multi-storey heating systems, central heating systems in the form of low temperature heating systems (LT heating systems) and sanitation systems are covered by professional planning, design and conception of the components of the MAINPRESS system.

LT heating systems are created so that the flow temperature automatically adapts to the outside temperature. The maximum temperature does not exceed 70°C, whereas the minimum temperature can fall to 30°C. Therefore, fewer pipeline and standby losses result as the temperature difference to room temperature and from the outside temperature is smaller.

Energy saving potential

Due to the applicable EnEV (Germany's Energy Saving Ordinance), the system can implement optimum solutions with an economically justifiable expenditure. Effective energy saving can be achieved using a clever combination of modern technology for the necessary heat production as well as our MAINPRESS composite pipe system.

Environment

As well as the aspects already referred to, a heating system today must also be considered from the point of view of environmental protection. Environmental protection concepts are taken into account through the use of environmentally-friendly materials and the practically waste-free assembly.

MAINPRESS - The multi-layer composite pipe

The MAINPRESS composite pipe is a pressure-resistant multi-layer composite pipe made from PE-RT/Alu/PE-RT. Due to the 100% oxygen impermeability, this pipe is ideal for use in the area of heating and sanitation.

Self-monitoring in the form of constant control of the production line as well as external monitoring by an independent testing institute guarantee adherence to all requirements for applicable pipe standards.

1.2 General notes

The operating temperature of the MAINPRESS system must be between -10°C and 70°C. Exceeding the continuous operation temperature is only intended for short periods of time. It must be ensured that the continuous operation temperature is not exceeded during regular application. The MAINPRESS system may not be used in systems such as, for example, solar and district heating systems, with operating temperatures above 70°C. It must be ensured that the parameters referred to above are not exceeded in any operating situation.

The changes in length due to temperature increase must be considered when laying MAINPRESS composite pipes. Expansion compensators must be installed in the case of larger changes in length of pipelines which run straight without bending legs (from approx. 20 metres). The composite pipe is resistant to corrosion due to its material properties. In the case of professional assembly of the fitting, contact corrosion is also not to be expected, as the stop ring separates the aluminium layer from the fitting body.

Classification of operating conditions - in accordance with ISO 10508 / DIN EN ISO 21003

Pipe performance requirements are specified for different application classes. The applicable classes are shown in the table below:

Application class	T _D		T _{max}		T _{mal}		Typical area of application
	°C	Time Years	°C	Time Years	°C	Time Hours	
1	60	49	80	1	95	100	Hot water supply (60°C)
2	70	49	80	1	95	100	Hot water supply (70°C)
4	20	2.5	70	2,5	100	100	Underfloor heating and low temperature radiator connections
	40	20					
	60	25					
5	20	14	90	1	100	100	High temperature radiator connection
	60	25					
	80	10					

T = Temperature, T_D = Design temperature, T_{max} = Maximum design temperature, T_{mal} = Fault temperature

Each application class relates to a typical area of application and takes into account a service life of 50 years. Classification corresponds to the requirements in ISO 10508. All specified typical fields of application are recommendations and for guidance only.

Each application class has a corresponding permissible operating pressure of 4 bar¹, 6 bar, 8 bar or 10 bar, depending on the particular application.

¹ 1 bar = 10⁵ N/m² = 0.1 MPa applies

The concept of the application class defines the purpose of ISO 10508-4. The theoretical description of dynamic conditions within the application classes accurately reflects the reality compared to statistical data. Manufacturers, planners and installers are provided with a basis for the selection of suitable pipes for specific uses.

2. System components

2.1 The pipe



MAINPRESS - Multilayer composite pipe (PE-RT / Alu / PE-RT)



What are the advantages of metal composite pipes?

MAINCOR multi-layer composite pipes are aluminium composite pipes consisting of 5 layers which are longitudinally welded to overlap. Aluminium composite pipes are distinguished compared to all-plastic pipes by their increased resistance to temperature and pressure, as well as by their structural stability.

Technical properties

working temperature	70°C
max. temperature	95°C
working pressure	10 bar
standard colour inside	transparent
standard colour outside	white
other colours	on request
pipe printing	customer-specific
packing	box or foil

Application:

- drinking water installation
- radiator connection
- wall heating
- underfloor cooling
- underfloor heating

Standards:

- DIN EN ISO 21003
- DVGW W542

Approvals:

- DVGW DW8501-BU0326
- DVGW DW8236-BU0013
- SKZ A 462

diameter	outerdiameter (mm)	wall thickness (mm)	max. coil length (m)
14 x 2.0	14 + 0,3	2.0 + 0.3	500
16 x 2.0	16 + 0,3	2.0 + 0.3	500
20 x 2.25	20 + 0,3	2.25 + 0.3	250
25 x 2.5	25 + 0,3	2.5 + 0.3	100
32 x 3.0	32 + 0,3	3.0 + 0.3	50
40 x 4.0	40 + 0,3	4.0 + 0.3	Bar
50 x 4.5	50 + 0,3	4.5 + 0.3	Bar
63 x 6.0	63 + 0,3	6.0 + 0.3	Bar

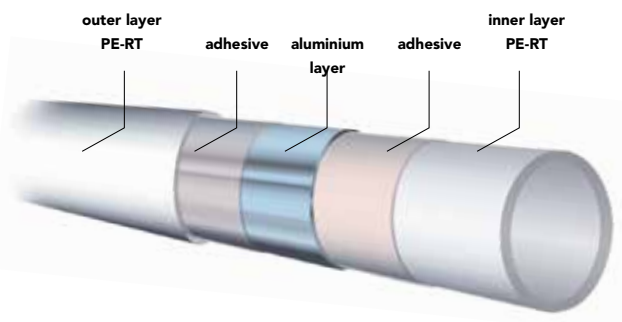

MAINCOR Rohrsysteme GmbH & Co. KG
Silbersteinstraße 14
97424 Schweinfurt

Subject to technical modifications and amendments!
Datenblatt_MSR_MPR_EN_04-19(THB)

2.2 The fitting

The MAINPRESS fitting is made of CW 617N (Pb < 2.2%; Ni < 0.1%) brass in accordance with the requirements of the DVGW worksheet W 534 as well as the Drinking Water Ordinance (UBA - list) and was developed specifically for the area of food, drinking water and heating.

The fitting is coated with a tin layer using a galvanic method. The profile ring assembled on the profile of the fitting consists of the EPDM material (with DVGW approval) and is suitable for a thermal application range from -40°C to +150°C and is suitable for drinking water. A pressing sleeve made from stainless steel is assembled on the fitting contour, with which the fitting is pressed onto the pipe.

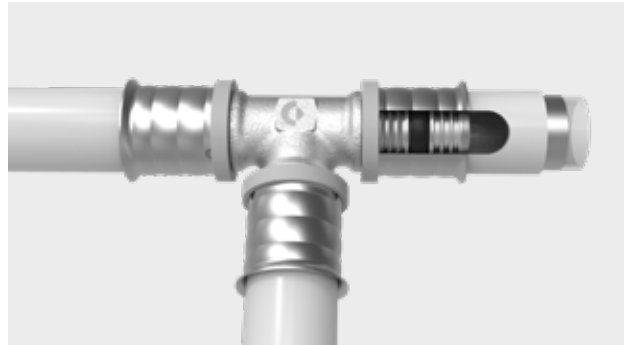

Influence / Protection of the drinking water

The MAINPRESS installation system is suitable for all drinking water qualities in accordance with the current Drinking Water Ordinance and can be used without restrictions, taking into consideration DIN 1988. The fittings are resistant to corrosion due to their material properties and correspond to the provisions of DIN 50930-6 as well as the recommendations of the Federal Environment Agency (UBA) and are therefore applicable in an unrestricted manner for all drinking water in the sense of the Drinking Water Ordinance.

Corrosion

It is possible to install MAINPRESS connectors in stainless steel installations, taking into consideration the recognized rules of engineering. No corrosion is to be expected in heating systems which have been executed professionally.

Generally, MAINPRESS fittings can be laid directly into plaster, floor screed or concrete. There are, however, exceptions in which this is not possible without suitable protection:

- permanent moisture
- pH value > 12.5

In such a case, standard corrosion protection coatings can be used.



MAINPRESS - PPSU Fittings



Product details

Description/Dim.	Code	PU
PPSU Elbow 90°	P41.500.XXX	depending on dimension
PPSU Tee	P41.300.XXX	depending on dimension
PPSU Coupler	P31.100.XXX	depending on dimension

unpressed unsealed

corrosion not possible (polymer)

low weight



DW-8501CM0499



in course of 2021

Advantages Material PPSU

- very robust high performance polymer
- outstanding impact resistance
- proven since years in sanitary applications
- hygienically non hazardous (medical use)
- lead free
- free of incrustations

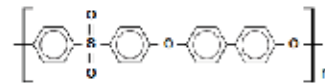

Inspection window
explicit recognition of the correct pipe positioning

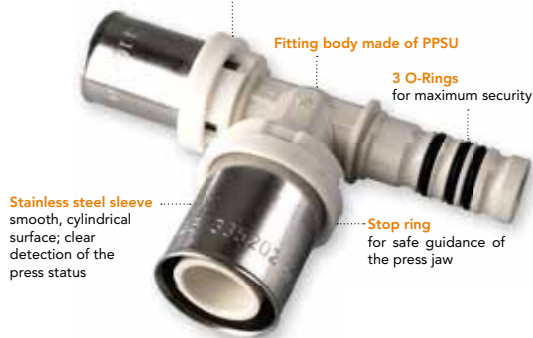

Technical properties

Density	1,29 g/cm ³
Tensile module	2.340 MPa
Tensile strength	70 MPa
Elongation	7,2%
Elongation at break	90%
Flexural module	2.410 MPa
Flexural strength	91 MPa
Glas transition temperature	220°C
Thermal conductivity	0,35 W/(mK)
Thermal expansion coefficient	5,6 10 ⁻⁵ /K

It is not necessary to use lubricants or other chemical substances during installation. Although PPSU can withstand a huge number of chemical agents, the contact to additional substances has to be avoided. Should this be necessary nevertheless, a clearance for the substance in question has to be obtained from MAINCOR.

* Yearly 3rd party testings are being performed by independent test laboratories to maintain the certification and ensure the continuous quality and functionality of MAINCOR's tap water systems.

System compatibility



- completely compatible to the MAINCOR MAINPRESS pipes
- installation with the usual MAINCOR MAINPRESS tools
- installation instructions & requirements of the Technical Manual MAINPRESS are also valid for the PPSU Fittings

















MAINCOR Rohrsysteme GmbH & Co. KG
Silbersteinstraße 14
97424 Schweinfurt

Subject to technical modifications and amendments!
Datenblatt_PPSU-Fittinge_EN_07-21

2.3 Resistance coefficients in accordance with DIN 1988-300

The resistance coefficient for the respective fitting can be read from the following tables. The table is created in the style of DIN 1988-300 Annex A and shows the resistance coefficients of different fittings in different sizes:

No.	Individual resistance ^b	Abbreviations in accordance with DVGW W 575	Graphical symbol ^a , simplified depiction	Resistance coefficient ξ									
				DN 12	DN 15	DN 20	DN 25	DN 32	DN 40	DN 50	DN 65	DN 80	DN 100
				Pipe outer diameter d_a mm									
				16	20	25	32	40	50	63	75	90	100
1	T-piece, branching, flow separation	TA		17.2	8.1	5.6	9.3	3.5	3.0	3.1	4.1	3.5	3.5
2	T-piece, passage, flow separation	TD		6.0	3.6	2.1	4.8	1.1	0.8	0.7	0.8	0.8	0.8
3	T-piece, counterflow, flow separation	TG		11.5	6.8	5.3	3.7	3.5	3.0	3.1	4.1	4.0	4.0
4	T-piece, branching, merging flow	TVA		17.0	10.0	8.0	5.0	5.5	4.5	4.0	3.5	3.5	3.5
5	T-piece, passage, merging flow	TVD		35.0	23.0	16.0	11.0	10.0	9.0	8.0	7.0	6.0	6.0
6	T-piece, counterflow, merging flow	TVG		27.0	17.0	12.0	9.0	8.0	7.0	6.0	5.0	5.0	5.0
7	Angle/bend 90°	W90		17.3	7.4	5.7	8.3	3.3	3.0	3.5	4.0	4.0	4.0
8	Angle/bend 45°	W45		3.0	2.5	2.0	1.5	1.5	1.0	1.0	1.0	1.0	1.5
9	Reduction	RED		3.1	2.6	2.0	1.0	1.0	1.3	0.3	0.5	0.4	-
10	Wall panel	WS		8.1	6.6	-	-	-	-	-	-	-	-
11	Double wall panel passage	WSD		5.0	4.5	4.0	-	-	-	-	-	-	-
12	Double wall panel branching	WSA		4.0	3.5	3.0	-	-	-	-	-	-	-
13	Manifold	STV		4.5	3.0	-	-	-	-	-	-	-	-
14	Coupling/socket	K		3.1	3.5	2.2	5.0	5.0	0.9	0.9	0.7	0.7	0.7

3. Installation

3.1 Press connection

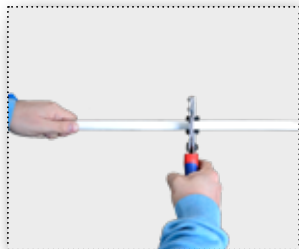

Cut the MAINPRESS composite pipe to length at a right angle using the corresponding original tool by MAINCOR. Then deburr the pipe until a circumferential bevel is evident. The bevel is necessary in order to prevent damage to the profile rings. The bevel must be checked before insertion. The correct insertion depth can be checked using the incorporated viewing window on the fitting. Put pressing jaws on the sleeve between the stops. Ensure that the pressing jaw abuts properly onto the stop ring. Then trigger the pressing procedure with the pressing machine. The pressing jaw must be completely closed at the end of the pressing procedure.

Deburring

MAINPRESS multi-layer composite pipes in dimensions 16 to 25 must be calibrated and deburred before inserting into the MAINPRESS fitting. From dimension 32, the multi-layer composite pipe is only deburred. This is necessary to protect the profile ring. The dimension-dependant deburring tool must be inserted up to the stop in the pipe. This can occur by hand or using a battery-operated drill. If assembly by hand is not possible - the resistance is too large when inserting the fitting - the calibration and/or deburring was not executed properly. In this case, the insertion of the connector should be avoided and the calibration and deburring of the pipe should be repeated.

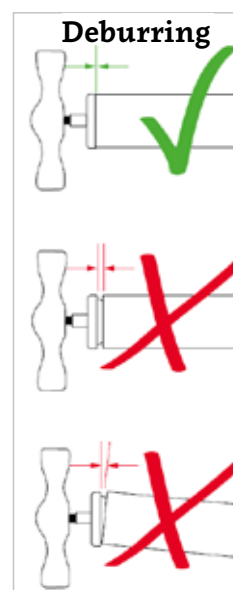
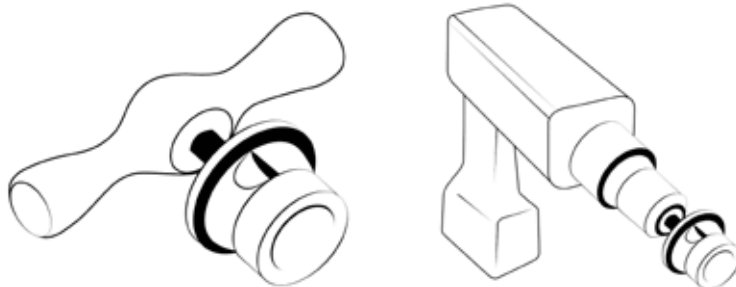

Compatibility of pressing machines / pressing jaws

The pressing machines listed in the table can be used in connection with the MAINPRESS pressing jaws, U-contour for the MAINPRESS system:

System	Pressing tool	Comments	MAINPRESS pressing jaws 16 - 32	MAINPRESS pressing jaws 40-50
Viega	Type 1 (old)		Yes	No
	Type 2 (new)	Serial number starting with 96	Yes	No
Viega / Von ARX	PT2H / Ridgid RP300	-	Yes	No
	PT3 AH / Ridgid RP300B	-	Yes	Yes
	PT3 EH	-	Yes	Yes
	Pressgun 4E / Ridgid RP330C	-	Yes	Yes
	Pressgun 4B / Ridgid RP330B	-	Yes	Yes
Von ARX	Ridgid RP 10B/10S	-	Yes	Yes
Mannesmann	Type EFP 1	Non-rotatable head	Yes	No
	Type EFP 2	Rotatable head	Yes	No
Geberit	Type PWH - 40	Black sleeve above pressing jaw fixture	Yes	No
	Type PWH - 75	Blue sleeve above pressing jaw fixture	Yes	No
Novopress	ECO 1 / ACO 1	-	Yes	Yes
	AFP 201 / EFP 201	-	Yes	Yes
	ACO - ECO 201 / 202 / 203	-	Yes	Yes
Vetec	SPM 32	-	Yes	Yes
REMS	Accu-Press ACC	-	Yes	Yes
	Power-Press ACC	-	Yes	Yes
KLAUKE	UAP3L, UAP2, UNP2	-	Yes	Yes

This compatibility list is not valid for the MAINPRESS pressing jaws in connection with the MAP1 /ACO 102 battery-operated tool.

Jaws bigger than size 50 aren't included in the compatibility and require individual checking.

3.1.1 Pressing dimension 63 with pressing jaws

MAINPRESS multilayer composite pipe 63, is being pressed with the new press jaws without the need of adapter jaws.



Open the press jaws by pushing the axle stub between thumb and index finger.



For a correct position of the press jaws on the fitting, the outer jaws pair encloses the fitting fully.



Subsequently, the pressing machine, with the third lower press jaws part, is brought into contact with the sleeve by pushing the fitting towards the machine. The fitting is then enclosed by all three parts of the press jaws.

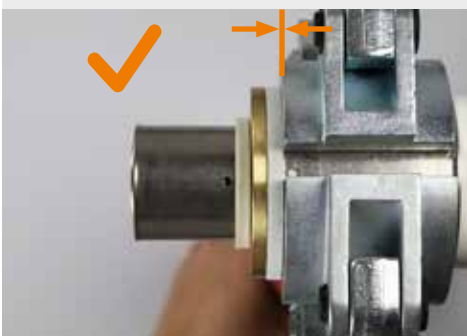

It is important to ensure that all three parts of the press jaws are rectangular and flush to the fitting.

After finishing the press procedure the fitting needs to be pulled out of the jaws again, so that the outer jaws pair is in its initial position (first picture)

3.2 Bending the pipe

In principle, the MAINPRESS composite pipe can be bent in compliance with the smallest bending radii. Bending is possible by hand or with a tool. If the pipes are bent by hand, both hands must be used in order to prevent buckling of the pipe bend. The pipes may not be bent directly at the connection.



Flexible springs or benders are approved as auxiliary tools. When bending with the inner flexible spring, the pipe end must firstly be deburred. During the bending procedure, the ribs of the flexible spring may not be visible on the outer coating.

The hot bending of the MAINPRESS composite pipe by means of open flames or other heat sources is forbidden. The repeated bending around the same bending point is prohibited. If the minimum bending radius is not met, a corresponding structural piece must be used.

	Bending radius by hand ($5 \times d_a$)	Bending radius using inner flexible spring ($4 \times d_a$)	Bending radius using machine ($4 \times d_a$)
16 x 2.0	80	64	64
20 x 2.25	100	80	80
25 x 2.5	125	100	100
32 x 3.0	160	128	128
40 x 4.0	-	-	-
50 x 4.5	-	-	-
63 x 6.0	-	-	-

The specified minimum bending radii must not be undershot! If a pipe is buckled or damaged in another way, this must be replaced or a corresponding structural piece must be used.

3.3 Pipe runs and fastening

Pipe runs in the floor structure must be planned in such a way that they do not cross. The pipe runs should be made as straight as possible, in parallel to the walls and the axes. As a rule, pipe runs crossings lead to larger construction heights. This can be avoided by careful planning. Pipe clips and fastening materials for the MAINPRESS composite pipe system may only be used if these are suitable for the pipe material and the pipe diameter. Requirements regarding clip protection and length expansion must be considered.

- When fastening, the entire weight of the system during function must be considered. Fastener spacings can be found in the system data overview.
- Wall and ceiling openings must be executed such that the regulations in the areas of fire protection and sound insulation in buildings are adhered to.
- Direct contact with wall and concrete parts is not permitted.
- Fittings and MAINPRESS composite pipe must be protected from external influences such as aggressive media and materials, UV radiation and saline air.
- Depending on the application, the sealing of wall and ceiling openings does not have to be executed in accordance with the regulations for fire protection and sound insulation as well as in accordance with the recognised technical regulations.

Pipes moulded into floor screed or into concrete

Due to the relatively low expansion forces of the pipes, no compensation measures are necessary in the case of direct embedding into concrete or floor screed. Due to the plastic deformability of multi-layer composite pipes, the resulting forces are intercepted by the pipe wall, but the requirements for heat and impact sound insulation must be considered.

Pipes in the floor structure

In that MAINPRESS multi-layer composite pipes can move axially within the insulation without great resistance, the expected changes in length must be intercepted at right-angled diversions in the insulation later. Insulated pipelines which are already laid in the floor must be protected from damage during the construction phase. Before completion of the floor structure, it must be checked that insulated pipes which are laid on the floor are not damaged. Damages must be resolved to guarantee heat and sound insulation.

When laying pipes above the floor, the following principles should be considered

- Lay pipelines thermally insulated and acoustically decoupled
- Avoid pipe crossings as far as possible
- Lay pipelines in parallel to walls
- Pipelines flow into adjacent walls at right angles
- Maximum width of the pipelines 120 mm
- Minimum spacing between pipelines and walls in hallways 200 mm, in living area 500 mm.
- Wrap pipeline though floor screed expansion joints with corrugated tube or alternatively with 6 mm pipe insulation (plain bearings).

Pipelines laid under plaster

Pipelines laid under plaster should always be insulated in order to compensate for length expansion forces of the pipes during temperature increase. Damages in the plaster can thereby be avoided. If no heat insulation is required, the composite pipe can be laid in a protective tube. In principle, direct contact with plaster, cement, tile cement, etc. must be avoided by suitable measures.

Freely suspended pipelines and pipelines laid under plaster

Freely suspended pipelines and pipelines laid under plaster must be fastened with pipe clips in accordance with the table under point 2.1 and in accordance with thermal and sound insulation. Thermal changes in length must be taken into account, if necessary, by the arrangement of bending legs in connection with fixed points and plain bearings.

Distance between fastenings (m)	16 x 2,0	20 x 2,25	25 x 2,5	32 x 3,0	40 x 4,0	50 x 4,5
horizontal	1,2	1,3	1,5	1,6	1,7	2
vertical	1,5	1,6	1,8	2,0	2,2	2,6

Protection from exterior corrosion

MAINPRESS fittings must be protected from external corrosion (which occurs due to moisture and the influence of oxygen, saline air or aggressive ambient materials), if necessary, by corrosion protection coatings.

3.4 Insulation of MAINPRESS pipes

Drinking water installation

In order to select the correct insulation layer thickness for the drinking water installation, hot and cold water installations must be differentiated between. In principle, the insulation should act in opposite ways for each application. The insulation in the hot water installation serves to reduce heat losses, whereas the insulation in the cold water installation is used to prevent the undesired introduction of heat into the cold water line and to prevent the formation of condensation.

The requirements for minimum insulation layer thicknesses are regulated in DIN 1988-200, as well as in the EnEV (Energy Saving Ordinance). The insulation layer thicknesses relate to the specified heat conductivity and can be reduced if the same limit of heat dissipation can also be ensured with other types of insulation.

Drinking water - cold			Drinking water - hot		
No.	Installation situation	Insulation layer thickness 0.040 W/(m x K) ^a	No.	Installation situation	Insulation layer thickness 0.035 W/(m x K)
1	Pipelines laid freely in non-heated rooms, ambient temperature < 20°C (only condensation protection)	9 mm	1	Inner diameter up to 22mm	20 mm
2	Pipelines laid in pipe shafts, floor channels and suspended ceilings, ambient temperature ≤ 25°C	13 mm	2	Inner diameter greater 22mm to 35mm	30 mm
3	Pipelines laid, for example in technology centres or media channels and shafts during heat loads and ambient temperatures ≥ 25°C	Insulation such as hot water pipeline	3	Inner diameter greater 35mm to 100mm	Same inner diameter
4	Multi-storey pipelines and individual supply lines in pre-wall installations	Pipe-in-pipe or 4mm	4	Inner diameter greater 100mm	100 mm
5	Multi-storey pipelines and individual supply lines in the floor structure (also in addition to non-circulating drinking water pipelines hot) ^b	Pipe-in-pipe or 4mm	5	Pipelines and fittings according to installation situation 1 to 4 in wall and ceiling openings, in crossing regions of pipelines, at pipeline connection points, at central pipeline network distributors	Half of the requirements for installation situation 1 to 4
6	Multi-storey pipelines and individual supply lines in the floor structure in addition to hot circulating pipelines ^b	13 mm	6	Drinking water pipelines hot, which are neither integrated into the circulation circuit nor are designed with a heating cable, for example multi-storey or individual supply lines with a water content < 3l	No insulation requirements against heat dissipation ^b
^a The insulation layer thicknesses must be converted accordingly for other thermal conductivities; Reference temperature for the specified thermal conductivity: 10°C.			^a The insulation layer thicknesses must be converted accordingly for other thermal conductivities; Reference temperature for the specified thermal conductivity: 40°C.		
^b In connection with underfloor heating, the pipelines for drinking water cold must be laid such that the requirements in accordance with §3.6 DIN1988-200 are adhered to.			^b Insulation is required for laying under plaster (for example pipe-in-pipe or 4mm as mechanical protection or corrosion protection).		

Heating installation

Heating pipelines must be insulated against heat loss just as hot drinking water pipelines. The table across from this explains which insulation layer thickness is required in accordance with the EnEV (Energy Saving Ordinance) 2014. As far as in the cases of §14 Paragraph 5, heat distribution and hot water pipelines border on ambient air, these must be insulated with double the minimum thickness in accordance with Table 1, Lines 1 to 4.

Pipeline insulation in accordance with EnEV (Energy Saving Ordinance)

No.	Installation situation	Insulation layer thickness 0.035 W/(m x K)
1	Inner diameter up to 22mm	20 mm
2	Inner diameter greater 22mm to 35mm	30 mm
3	Inner diameter greater 35mm to 100mm	Same inner diameter
4	Inner diameter greater 100mm	100 mm
5	Pipelines and fittings according to installation situation 1 to 4 in wall and ceiling openings, in crossing regions of pipelines, at line connection points, at central pipeline network distributors	Half of the requirements for installation situation 1 to 4
6	Heat distribution pipelines according to installation situations 1 to 4, which are laid in components between heated rooms of different users after 31 January 2002	Half of the requirements for installation situation 1 to 4
7	Pipelines according to installation situation 6 in the floor structure	6 mm
8	Cold distribution and cold water pipelines as well as fittings for ventilation technology and air conditioning systems	6 mm

The insulation requirements which are set in the EnEV (Energy Saving Ordinance) 2014 and were explained in the table above are more or less complex. In practice, the following table is vital for daily use.

Use	Multi-family house / non-residential building several users	Single-family house / non-residential building 1 user
Pipelines in unheated rooms and cellar rooms	100%	100%
Pipelines in outer walls, outer components, between an unheated and heated room, in shafts and channels	100%	100%
Distribution lines for the supply of several different users	100%	Keine Anforderung
Pipelines laid in the floor, also radiator connection lines against the ground / unheated rooms ¹⁾	100%	100%
Pipelines and fittings in wall and ceiling openings, in the crossing region of pipelines, at pipeline connection points, at central pipeline distributors	50%	50%
Pipelines in components between heated rooms of different users	50%	No requirement
Pipelines laid in the floor structure, between heated rooms of different users	see EnEV (Energy Saving Ordinance), Tab. 1, Annex 5, Line 7 ²⁾	No requirement
Heating lines in heated rooms or in components between heated rooms of one user and capable of being shut off	/	No requirement
¹⁾ Eccentric/asymmetrical pipe tubing is admissible for limiting heat dissipation. The nominal thickness must be arranged towards the cold side. Details can be gleaned from the necessary General Building Supervisory Approval (ABZ) of the respective manufacturer.		
²⁾ Although no requirements are stated here, it must be insulated due to corrosion protection, cracking and flowing noises, structure-borne insulation as well as reduction of the thermal load.		

As the insulation layer thickness can be reduced if the same limit of heat dissipation is ensured, we have created a comparative table. This shows the dependency of thermal conductivity and pipe dimension with respect to the insulation layer thickness.

Minimum thickness of the insulation layer for pipe 100%
(EnEV (Energy Saving Ordinance) 2014, Annex 5, Table 1)

Thermal conductivity	Pipe dimensions						
	16 x 2.0	20 x 2.25	25 x 2.5	32 x 3.0	40 x 4.0	50 x 4.5	63 x 6.0
0.025	11	11	12	17	18	24	30
0.030	15	15	16	23	24	32	40
0.035	20	20	20	30	30	41	51
0.040	26	26	25	38	38	51	63
0.050	44	41	39	59	57	77	95

Minimum thickness of the insulation layer for pipe 50%
(EnEV (Energy Saving Ordinance) 2014, Annex 5, Table 1)

Thermal conductivity	Pipe dimensions						
	16 x 2.0	20 x 2.25	25 x 2.5	32 x 3.0	40 x 4.0	50 x 4.5	63 x 6.0
0.025	6	6	6	9	9	13	16
0.030	8	8	8	12	12	17	21
0.035	10	10	10	15	15	21	26
0.040	13	13	12	18	18	25	31
0.050	20	19	18	27	26	36	44

3.5 Fire protection

Fire protection is everywhere in daily life. For this reason, there are numerous laws and guidelines as well as corresponding regulations. The fundamental regulation is located in the Model Building Code of the Bauministerkonferenz (Conference of the Ministers of Construction) in the version of November 2002. Here, §14 defines what is to be understood exactly by fire protection.

§14 MODEL BUILDING CODE

Structural systems must be arranged, established, changed and maintained such that the development of a fire and the spreading of fire and smoke (spread of fire) is prevented and, during a fire, the escape of people and animals as well as effective extinguishing work are possible.

The subject of fire protection concerns everyone. Both the planner and the processor must be informed about the applicable standards and laws of the Bundesländer (Federal States).

For pipeline systems, installation shafts and channels, §40 of the Model Building Code states:

1. Pipelines may only be inserted through room-separating components for which a fire resistance capability is prescribed, if a spread of fire is not to be feared for a sufficiently long time or provisions are made against this. This does not apply:
 - for buildings of building classes 1 and 2
 - within flats
 - within the same utilisation unit with no more than a total of 400 m² on no more than two levels
2. Pipeline systems are only admissible in required staircases, in spaces in accordance with §35 Paragraph 3 Sentence 2 and in required halls if a use as an escape route in the case of fire is possible for a sufficiently long time.
3. For installation shafts and channels, Paragraph 1 as well as §41 Paragraph 2 Sentence 1 and Paragraph 3 apply accordingly.

In accordance with §40, the arrangement of the pipelines must correspond to the MLAR/LAR/RbALei (Model Pipeline System Guidelines/Pipeline System Guidelines/Guideline for Fire Protection Requirements for Pipeline Systems). The selection of the building material is very important in order to ensure preventive fire protection. DIN 4102 regulates this. The planning and assembly aid for pipeline systems by the company, Rockwool, is adapted to the subject to be correspondingly large. The extract of the planning and assembly aid is located on the next page, which describes the MAINCOR pipes in connection with fire protection.

In buildings in which fire protection requirements exist, supply lines may only then be passed through walls, ceilings, etc., if it is ensured that a transfer of fire and smoke is not to be feared or precautions are taken against this. Fire protection openings must be approved and checked. Such openings are pipe openings made from a specific insulating material, or fire protection collars which swell with heat input and which seal the opening to be resistant against fire and smoke.

In principle, the provisions from DIN 4102 Fire protection in building construction and the corresponding Federal Building Codes must be considered. Furthermore, procedures are proposed in the MLAR (Model Pipeline System Guidelines). For the MAINPRESS installation pipe system, a pipe opening by Rockwool is used in order to implement a fire protection solution.

3.4 Plastic / multilayer composite pipe

R 30 - to R 90 pipe opening for the MAINCOR installation system for non-flammable media e.g. potable water, heating

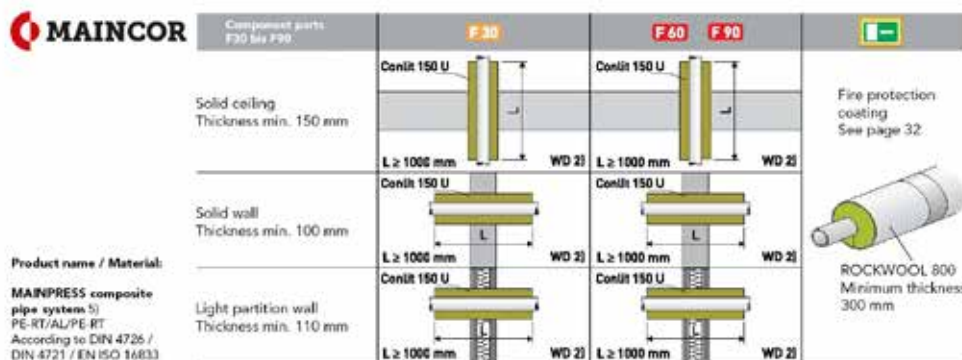

Product name / Material:
MAINPRESS composite pipe system 5)
 PE-RT/AL/PE-RT
 According to DIN 4726 / DIN 4721 / EN ISO 16833

MAINPEX sliding sleeve system 5)
 PE-RT/AL/PE-RT
 According to DIN 4726 / DIN 4721 / EN ISO 16833

Design variants in accordance with ROCKWOOL abP P-3226/4140-MPA BS
 Further instructions for planning/assembly, see chapter 2

System	Pipe dimension	Conilit 150 U			ROCKWOOL 800 [1] [2] [3]		
		Type 3)	Insulation thickness 4)	Core drilling Dk [mm]	EnEV 100 % Warm, Type	EnEV 50 % Warm, Type	DIN 1988-200 Cold Type 3)
MAINPRESS Composite pipe system	16,0	16/22	22,0	60	18/20	18/20	18/20
	20,0	20/20	20,0	60	22/20	22/20	22/20
	25,0	25/17,5	17,5	60	28/20	28/20	28/20
	32,0	32/24	24,0	80	35/30	35/20	35/30
	40,0	40/20	20,0	80	42/40	42/20	42/40
	50,0	50/25	25,0	100	54/40	54/30	54/40
MAINPEX Sliding sleeve system	16,0	16/22	22,0	60	18/20	18/20	18/20
	20,0	20/20	20,0	60	22/20	22/20	22/20
	25,0	25/17,5	17,5	60	28/20	28/20	28/20
	32,0	32/24	24,0	80	35/30	35/20	35/30
	40,0	40/20	20,0	80	42/40	42/20	42/40
	50,0	50/25	25,0	100	54/40	54/30	54/40

Instructions/Special installation requirements

- 1) In some cases the deliverable minimum insulation thickness is specified
- 2) As further insulation, the insulation shell ROCKWOOL 800 can be used
- 3) With cold pipes a vapour barrier must be used according to DIN 1988-200; therefore, exclusively use fire protection coating Conilit 150 U / 800 ROCKWOOL insulating shell
- 4) Insulation thickness according to DIN 1988-200 EnEV 50% and suited to the core drilling diameter Dk
- 5) Coatings such as conduits or factory insulation must be removed in the area of feed through

All requirements of the specified general building inspector certificates (abP) must be followed.

See: http://download.rockwool.de/media/300973/br_pm_rohrleitungsanlagen.pdf

3.6 Sound insulation

DIN 4109 regulates the requirements for protection against airborne and impact sound transfer between external living and work spaces as well as from structurally connected facilities, against noises from domestic systems and against outside noise. The maximum installation noise level L_{in} in housing of $\leq 30\text{dB(A)}$ at the moment corresponds to the recognized rules of engineering as well as the current jurisdiction. An extended sound insulation per working contract can be agreed over DIN 4109 in accordance with VDI 4100. The classification of the sound insulation steps in VDI 4100 is similar to those of DIN 4109. However, additionally, many useful notes for sound insulation planning can be found in the VDI guidelines 4100.

Supplementary table A1 from DIN 4109

Noise source	Type of rooms in need of protection	
	Living rooms and bedrooms	Teaching and work rooms
Water installations (water supply and waste water systems)	$\leq 30\text{ dB(A)}$	$\leq 35\text{ dB(A)}$
Other domestic systems	$\leq 30\text{ dB(A)}$	$\leq 35\text{ dB(A)}$
Facilities day 6am to 10pm	$\leq 35\text{ dB(A)}$	$\leq 35\text{ dB(A)}$
Facilities night 10pm to 6am	$\leq 25\text{ dB(A)}$	$\leq 35\text{ dB(A)}$

a) Individual short-term peaks which result during confirmation of the fittings and devices according to Table 6 (opening, closing, changing, interrupting, etc.), are not able to be considered at this time.

b) Work contract requirements for the fulfilment of the admissible installation sound pressure level:

- The execution documents must consider the requirements of sound insulation, i.e. among other things, the required sound insulation certificates must be present for the components
- Furthermore, the responsible construction management must be named and must be consulted for participation before sealing or covering the installation. The ZVSHK data sheet regulates further details.
(Can be obtained from: Central Association Plumbing, Heating and Air Conditioning (ZVSHK), Rathausallee 6, 53757 Sankt Augustin)

c) Values which are higher by 5 dB(A) are admissible for ventilation systems, as long as they are prolonged noises without striking individual tones.

In principle, with the following simple measures, structure-borne sound transfer can be prevented in drinking and waste water systems:

- The coating of the installation pipes with sound-absorbing materials (e.g. normal insulation) for pipe openings through walls or ceilings
- Sufficient dimensioning of the pipes in order to prevent flow noises
- Use sound insulation inserts (e.g. rubber) in fastening clips, wall brackets, devices as well as furnishings.

It is important that a written agreement with the respective other party is made concerning the required sound insulation level. DIN 4109 represents the recognised rules of engineering which must be adhered to according to building regulations.

3.7 General guidelines

All MAINPRESS system components are well protected in the original packing. Therefore, all components (fittings and pipes) should be protected from mechanical damage/impairment and that caused by weather conditions. For reasons of hygiene, surfaces in contact with water must be provided with end caps.

Impairment by UV radiation

MAINPRESS multi-layer composite pipes must be protected from direct, intense solar radiation and ultraviolet (UV) radiation. This relates both to the storage of the pipes and to completed system parts. They should therefore not be stored unprotected in the open. Completed systems or system parts must be protected with suitable measures against the effect of UV radiation.

Assembly guidelines of press fitting

- Cut the pipe to length at a right angle
- Calibrate and chamfer pipe end circumference
- Slide pipe into the fitting until the stop
- Check the viewing window in the pressing sleeve
- Press the press fitting

Potential equalisation

VDI 0190, Parts 410 and 540 call for a potential equalisation between the protective conductors and the „conductive“ water, waste water and heating pipes. The MAINPRESS installation pipe systems do not constitute conductive pipe systems and cannot be used for potential equalisation. Therefore, they also do not need to be earthed. The potential equalisation occurs directly at the potential equalisation rail at the position provided in the plan in accordance with the corresponding VDE guidelines of the components to be earthed. It must be checked by an approved electrician that the installation does not impair the electrical protection and earthing measures which are present (see for this purpose VOB (Construction Contract Procedures), Part C, ATV (General Technical Contractual Conditions)).

Processing temperature

The processing temperature for the MAINPRESS installation pipe system should not fall below -10°C.

Anti freezing agents

When using MAINPRESS installation pipe systems in pipe networks which are protected from frost, MAINCOR recommends the use of ethylene glycol. This can be used up to a maximum concentration of 35%. This concentration corresponds to a frost protection of approximately -20°C. Before using alternative frost protection sets, approval should be requested from the manufacturer.

Sealing

The manufacture of a threaded connection must occur in accordance with DIN 30660. We recommend the use of hemp in connection with an approved sealing paste (e.g. Fermit). Only so much hemp should be applied so that the thread tips can still be seen. In the case that too large a quantity of hemp is used, there is a risk of damage to the inner thread. By sealing with hemp shortly after the first thread, screwing in at an angle is avoided. Other sealants can be used as an alternative to hemp (e.g.: sealing chord, sealing tape, etc.) in accordance with the manufacturer's specifications.

In order to prevent an impairment of the MAINPRESS installation system, contact with materials containing solvents (e.g.: foam, paints, sprays, glues, etc.) must be prevented.

Tips and notes

Our employees are readily available to help you during planning. Contact your responsible sales representative.

Approximate assembly times

MAINPRESS multi-layer composite pipe in mm	Nominal widths	Assembly times for linear metres (completely laid incl. fastening in group minutes)
16	DN 12	4 - 8 min
20	DN 15	5 - 9 min
25	DN 20	6 - 10 min
32	DN 25	7 - 11 min
40	DN 32	13 - 15 min
50	DN 40	15 - 17 min

The specified assembly times are absolute approximate values in group minutes. Calculation for fitters with system experience.

All other secondary services are not included.

Hot water tank

The possible temperature limit of the MAINPRESS composite pipes may not be exceeded in normal operation and during breakdown. This applies in particular for the use of solar storage tanks or direct fired hot water tanks. Maximum hot water output temperatures must be checked during start-up or must be requested from the respective manufacturer or supplier.

Instantaneous water heaters

Inadmissibly high temperatures and pressures can result during use of instantaneous water heaters. In order to prevent damage to the MAINPRESS composite pipe system, device manufacturer specifications must be considered across the board.

Fittings

The assembly of fitting connections must occur so that they are fundamentally non-rotatable.

Moisture protection

DIN 18195-5 regulates the required moisture protection in sanitary facilities. For domestic bathrooms with moisture-sensitive perimeter components, the protection against moisture must be considered during planning. Because of the frequent use of plaster building materials and wood materials in the bathroom, it is strongly recommended to execute moisture protection measures. This applies in particular for fitting connections „under plaster“ as well as for openings in plaster for bathtubs and showers.

3.8 Heating with MAINPRESS

Requirements for the dimensioning of a pump hot water heating system:

- Enter radiators and heat outputs in floor plan / pipeline system plan
- Define pipe layout exactly
- Number individual sections from the heat generators to the radiators
- Enter respective heat outputs and pipe lengths in the pipeline system diagram

Typical values for an estimated dimensioning of the pipelines:

Installation location	Estimated MAINPRESS pipe
Radiator connection lines	16 x 2.0
Risers for 2-3 radiators	20 x 2.25 to 25 x 2.5
Riser and horizontal distribution from 5 radiators	25 x 2.5 to 32 x 3.0

Regulation of the system

In accordance with VOB/C (Construction Contract Procedures) - DIN 18380, hydraulic compensation must be implemented. The compensation ensures that all heat consumers (radiators) are supplied according to their heat requirement or become warm evenly. A final adjustment of regulation values (e.g. flow temperature, heating curve) occurs at the end of the first heating period or after completion of the building. For the proper maintenance of pressure, the form of the membrane expansion tank must be adjusted correctly.

Acceptance

- Complete testing of the system
- Compliance with technical or official regulations
- Functional testing within the framework of a trial operation

Instruction concerning transfer

- Occurs through the system creator
- Comprises the presentation of test certificates, maintenance and operating manuals

Maintenance

For heating systems which require qualified operating personnel, operating and maintenance manuals must be created in accordance with DIN 12170.

General

Our employees are readily available to answer any questions you may have. Please contact the technical department or the responsible sales representative. Additionally, MAINCOR clients have the opportunity to use free-of-charge programmes for the estimated calculation of heating, sanitation and ventilation systems via our homepage by means of their client number and a self-selected password.

The information and technical data contained in the manuals, catalogues and other written documents such as, for example, drawings and plans, must be checked by the buyer before acceptance and use. The buyer cannot derive any claims against MAINCOR or its employees from these documents and additional services, unless these have acted in an intentionally or grossly negligent manner. MAINCOR reserves the right to carry out changes to its products, even to those which have already been commissioned, without prior notice, within appropriate and reasonable limits.

Pipe performance data

Spread	10 K	15 K	20 K	m	R	w
Pipe dimensions	max. heat output Q [KW]			[kg/h]	[Pa/m]	[m/s]
16 x 2.0	1.20	1.90	2.50	104.00	99.00	0.25
20 x 2.25	2.50	4.00	5.00	233.00	111.00	0.33
25 x 2.5	5.00	7.50	10.00	434.00	105.00	0.39
32 x 3.0	10.00	16.00	20.00	866.00	100.00	0.46
40 x 4.0	18.00	27.50	37.50	1612.00	109.00	0.56
50 x 4.5	32.00	52.50	70.00	3009.00	101.00	0.64
63 x 6.0	62.50	95.10	120.00	5374.00	103.00	0.73

Recommended maximum pressure losses:

Heating systems: 100 - 200 Pa/m

Underfloor heating systems: 100 - 200 Pa/m

Recommended maximum flow velocities:

Radiator connection lines: up to 0.5m/s

Heat distribution lines: up to 1.0m/s

3.9 Tap water with MAINPRESS

Essential planning foundations:

- DIN 1988 - 100 / 200 / 300
- DIN EN 1717
- VDI 6029
- DIN EN 806
- Floor plans and building sections of the object
- Specifications - water heating
- Pipe material
- Available water supply pressure (information on the water supplier)

General requirements for drinking water heating systems (TWEA):

- Continuous availability of hot water requirement
- Hot water withdrawal without delay
- Simple operation
- Careful planning and assembly
- High operational safety
- Faultless operation in terms of hygiene
- Compliance with standards and regulations
- Precise dimensioning corresponding to use
- Use-orientated calculation of the hot water costs

Source: Claus Ihle, Rolf Bader, Manfred Golla; „Tabellenbuch Sanitär/Heizung/Klima/Lüftung-Anlagentechnik, Ausbildung und Praxis“ (Data manual for plumbing/heating/air conditioning and ventilation technology, training and practice); 6th edition, Bildungsverlag EINS GmbH, Troisdorf 2007

Dimensioning - planning foundations:

Drinking water is subject to the strictest legal hygiene requirements. With regard to professional dimensioning, this means that drinking water may not protrude into pipelines which are too generously dimensioned. Drinking water pipeline networks must be planned, dimensioned and laid in accordance with DIN 1988 - 100 / 200 / 300. Differentiated bases for calculation of the pipe diameter, maximum flow velocities as well as flow rate, connection and use values are regulated in DIN 1988-300.

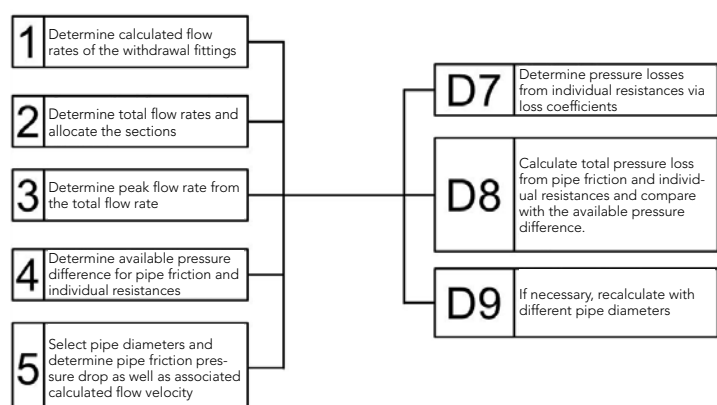

Maximum calculated flow velocity DIN 1988-300

Maximum calculated flow velocity for flow duration in m/s

Performance phase	< 15 min	> 15 min
House connection line	2.0	2.0
Consumption lines: Sections with resistance coefficients < 2.5 for the individual resistances ^{a)}	5.0	2.0
Consumption lines: Sections with resistance coefficients ≥ 2.5 for the individual resistances ^{b)}	2.5	2.0

^{a)} for example, piston valve, ball valve, angle seat valve

^{b)} for example straight seat valve

Withdrawal location	DN	Flow pressure	Temperature	Flow rate		Only cold or hot water
		P_{MF} in mBar	°C	V_{RKW} (l/s)	V_{RWW} (l/s)	R (l/s)
Discharge valve	15	500	-	-	-	0.3
Without air mixer	20	500	-	-	-	0.5
	25	500	-	-	-	1.0
Shower head	15	1000	38	0.15	0.15	-
Bathtub system, mixer tap	15	1000	40	0.15	0.15	-
	20	1000	40	0.5	0.5	-
Lavatory system, flush valve	15	1200	10	0.7	-	-
	20	1200	10	1.0	-	-
Cistern	15	500	10	0.13	-	-
Mixer tap	15	1000	50-55	0.07	0.07	-
	20	1000	50-55	0.3	0.3	-
Kitchen sinks, discharge valve	15	500	10	0.07	-	-
Row of washbasins, mixing valve	15	1000	35	0.07	0.07	-
Shower mixer	15	1000	38	0.15	0.15	-
Dishwasher	15	500	10	0.07	-	-
Washing machine	15	1000	10	0.15	-	-
Instantaneous water heater, electronically controlled	15	500	30-55	0.17	-	-
Gas / flow rate Multi-purpose water heater	Without pressure losses in safety or connection fittings of downstream pipelines and withdrawal fittings					
Q _{NL} 8.7 kW	15	800	30-60	0.07	-	-
Q _{NL} 17.4 kW	15	800	30-60	0.16	-	-
Q _{NL} 22.7 kW	15	1300	30-60	0.21	-	-
Q _{NL} 27.9 kW	15	1700	30-60	0.26	-	-

4. Tap water supply

4.1 Tap water

Drinking water is not usually sterile and may contain a certain amount of bacteria which has, according to experience, no effects on human health. Drinking water is any water which is specified for drinking, cooking, preparing food and drink or for the following domestic purposes:



- Personal hygiene
- Cleaning of objects which are intended to come into contact with food products
- Cleaning of objects which are intended to come into contact with the human body on more than a temporary basis

In accordance with the Drinking Water Ordinance (TrinkwV), water must fulfil the following requirements to be drinking water:

- colourless
- odourless
- free of pathogens
- having a content of dissolved mineral materials in specific concentrations
- neutral and cool in taste
- not damaging to health

Drinking water must be created such that damage to human health, in particular by pathogens, is not to be feared due to its consumption or use. It must be pure and fit for consumption.

Much has changed in drinking water distribution. Until recently, exclusively the water suppliers were obliged to supply perfect drinking water quality. To comply with this requirement, the water suppliers were only responsible for the quality until the transfer point of the water. The withdrawal location of the user, however, is usually not at the transfer location, but within the domestic installation. In accordance with the amendment to the Drinking Water Ordinance in December 2012, planners, installers and operators are now jointly responsible for providing the user with the best quality drinking water. The Federal Environment Agency defines this rather well: „Its the last few metres that count!“

4.2 Drinking water distribution

The relevant regulations, standards and directives such as DIN 1988, TrinkwV (Drinking Water Ordinance) etc. prioritise the hygienic protection of the drinking water. Therein, the water is defined at the consumption location in the form of limit values which can be checked accordingly at withdrawal locations or by means of special sampling fittings (this must also take place in the case of industrial use).

The responsibility for the use of the system as intended (temperature specifications) is incumbent upon the operator. The suitability of the system for the intended operation, so the compliance with limit values, is the responsibility of the planner or of the planning installer. I.e. the installation should be executed such that the hygiene risk is kept as low as possible.

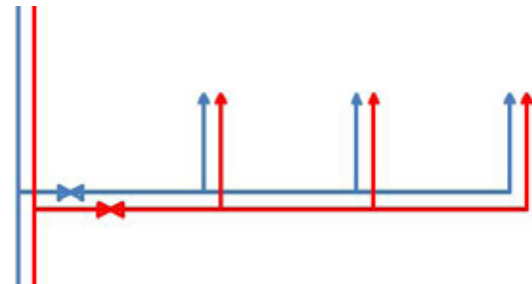

In drinking water distribution, T-piece distribution, series connection with U-shaped wall brackets and closed circular pipelines with U-shaped wall brackets are differentiated between. For reasons of hygiene, the „classic“ T-piece distribution should only be used at consumption locations which are used regularly and daily. A minimum hygiene risk cannot be ruled out as stagnating water remains in the short supply lines to the consumers.

In the case of the series connection with U-shaped wall brackets, stagnant water in the supply lines to the individual consumers is prevented. Therein, the mostly frequently used consumer should be installed at the end of the series. If the withdrawal location with the largest consumption is positioned at the beginning of the series, then a lower pressure loss is achieved than if the largest consumer were at the end of the series.

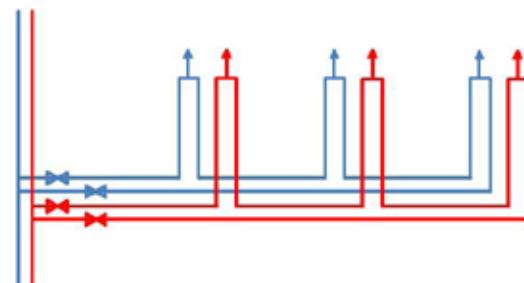

In the closed circular pipeline, a faultless installation in terms of hygiene is ensured as an optimum water exchange always takes place in the pipeline. Because the consumer is supplied from two sides, smaller pipe dimensions can be selected which also supports the water exchange.

In systems with several consumers which are not used regularly, such as, for example: hotels, hospitals, etc., from the point of view of risk minimisation, in fact only the variant of the closed circular pipeline installation with U-shaped wall brackets remains.

5. Rinsing and pressure testing

Pressure and leakage testing as well as rinsing of MAINCOR drinking water installations

in accordance with DIN EN 806-4 and ZVSHK data sheet
„Leakage testing of drinking water installations with compressed air,
inert gas or water“.



The pressure and leakage testing in accordance with DIN EN 806-4 or in accordance with the ZVSHK data sheet „Leakage testing of drinking water installations with compressed air, inert gas or water“ for the Maincor drinking water pipe systems, MAINPRESS, MAINPEX and MAINOX, must be implemented after the completion of the installation.

All components of the installation must be freely accessible and visible. If a regular water exchange is not ensured at the latest seven days after the pressure testing, then the implementation of a pressure test with compressed air or inert gas is recommended.

Special note for pressurising with compressed air or inert gases

All pipelines must be closed with metallic stoppers, caps, blanks or blind flanges. Closed shut-off fittings do not count as having been sealed closed. Devices, fittings, pressurised containers or drinking water heaters must be separated from the pipelines before the pressure test. A visual check of all pipe connections for professional execution was carried out. Leak detection spray can be used for leak detection.

Reports and certificates are to be supplied concerning the implementation of the pressure or leakage testing.

Pressure testing with compressed air or inert gas

Pressure testing with compressed air or inert gases (ZVSHK data sheet „Leakage testing of drinking water installations with compressed air, inert gas or water“)

Exclusively devices must be used, the measurement accuracy of which is +/- 1 mbar.
During the test(s), the pressure at the pressure gauge must be monitored continuously.

After a visual test of all connection points, the leakage testing is to be implemented as follows:

Testing pressure: 150 mbar
Testing time: 120 minutes for systems with a volume of up to 100 litres
(+20 minutes per 100 litres of additional volume)

The connectors must be checked for leakages.

In connection to this, the load testing occurs as follows:

Increase of the testing pressure to 3 bar (1 bar for dimensions > 63 mm), testing time at least 10 minutes

The connectors must be checked for leakages.

A report concerning the leakage testing must be produced in which the impermeability of the system is documented and confirmed.

Testing report for MAINCOR drinking water installations

Pressure testing medium: oil-free compressed air nitrogen carbon dioxide _____

Construction project: _____

Construction phase: _____

Tester / Company: _____

MAINCOR installation system used:

MAINPRESS

MAINPEX

MAINPEX with PE-Xc

MAINOX

Pipeline volume: _____ litres Temperature of testing medium: _____ °C

A visual check of all pipe connections for professional execution was carried out.

LEAKAGE TESTING:

Testing pressure: 150 mbar.

Testing time up to 100 litres pipeline volume at least 120 minutes.

The testing time must be increased by 20 minutes per additional 100 litres.

Once the temperature level and equilibrium is reached, the testing time begins.

Start: _____ (date, time) Testing pressure: _____ mbar

End: _____ (date, time) Testing pressure: _____ mbar

During the testing time, no pressure drop was determined.

LOAD TESTING:

Testing pressure: Installation pipe $d_a \leq 63$ mm max. 3 bar, Installation pipe $d_a > 63$ mm max. 1 bar.

Testing time up to 100 litres pipeline volume at least 10 minutes.

Once the temperature level and equilibrium is reached, the testing time begins.

Start: _____ (date, time) Testing pressure: _____ bar

End: _____ (date, time) Testing pressure: _____ bar

During the testing time, no pressure drop was determined.

CONFIRMATION OF THE SYSTEM IMPERMEABILITY: No leakages could be determined in the aforementioned system, neither during the leakage testing, nor during the load testing.

(place, date)

(stamp, contractor signature)

(place, date)

(stamp, customer signature)

Pressure testing with water

Pressure testing with water (DIN EN 806-4 or ZVSHK data sheet „Leakage testing of drinking water installations with compressed air, inert gas or water“)

Exclusively devices must be used, the measurement accuracy of which is +/- 0.1 mbar. During the test(s), the pressure at the pressure gauge must be monitored continuously. Exclusively filtered drinking water (particle size <150µm) must be used. The correct ventilation of the system must be ensured during filling. Shut-off elements in front of and behind heat generators and tanks must be closed. The system is filled with filtered water and ventilated completely. During the testing, a visual check of the pipe connectors must be carried out. The temperature equalisation between ambient temperature and the temperature of the water must be considered after production of the testing pressure by a corresponding waiting time. The testing pressure must be produced again after the waiting time, if necessary.

During use of the **MAINPRESS** drinking water system, first a check of the „unpressed, leaking“ connector must be carried out:

Testing pressure: 3 bar
Testing time: 15 minutes

The connectors must be checked for leakages.

After a visual test of all connection points, the **leakage testing itself** is to be implemented as follows for all MAINCOR systems:

Testing pressure: 11 bar
Testing time: 30 minutes

In the case of the use of the **MAINPEX** drinking water system with pipelines made from PE-Xc, an additional test is required:

Testing pressure: 5.5 bar (adjust by relieving the initial test pressure)
Testing time: 120 minutes

A report concerning the leakage testing must be produced in which the impermeability of the system is documented and confirmed.

Leakage testing report for MAINCOR drinking water installations

Pressure testing with test medium „water“

Construction project: _____

Construction phase: _____

Tester / Company: _____

MAINCOR installation system used:

MAINPRESS

MAINPEX

MAINPEX with PE-Xc

MAINOX

Pipeline volume: _____ litres Temperature of testing medium: _____ °C

A visual check of all pipe connections for professional execution was carried out.

LEAKAGE TESTING PRESSING CONNECTOR:

Testing time: 15 minutes

Testing pressure: 3 bar

Start: _____ (date, time)

Testing pressure: _____ bar

End: _____ (date, time)

Testing pressure: _____ bar

LEAKAGE TESTING:

Testing time: 30 minutes

Testing pressure: 11 bar

Start: _____ (date, time)

Testing pressure: _____ bar

End: _____ (date, time)

Testing pressure: _____ bar

LEAKAGE TESTING FOR PE-Xc-PIPE:

Testing time: 120 minutes

Testing pressure: 5.5 bar

Start: _____ (date, time)

Testing pressure: _____ bar

End: _____ (date, time)

Testing pressure: _____ bar

No pressure drop was determined at the pressure gauge during the testing time

CONFIRMATION OF THE SYSTEM IMPERMEABILITY: No leakages could be determined during the entire testing on the aforementioned system.

(place, date)

(stamp, contractor signature)

(place, date)

(stamp, customer signature)

Rinsing of MAINCOR drinking water installations

For reasons of hygiene, the rinsing should only occur directly before the start-up. Filtered drinking water must be used as a rinsing fluid.

In principle, two rinsing techniques can be applied:

- Rinsing with a water/air mixture in accordance with DIN EN 806-4 should be applied, if a sufficient rinsing effect cannot be expected when rinsing with water. See for this purpose technical rules for drinking water installation DIN EN 806-4 Section 6.2.3.
- The rinsing method with water corresponds to the specifications in the ZVSHK data sheet „Rinsing, disinfecting and start-up of drinking water installations“. More detailed information on the rinsing method with water can be gleaned from these booklets which can be obtained from the Central Association Plumbing Heating Air Conditioning (ZASHK).

A report on the rinsing procedure must be produced in which the proper rinsing of the drinking water system is confirmed.

Rinsing report for MAINCOR drinking water installations

Rinsing medium water

Construction project: _____

Construction phase: _____

Tester / Company: _____

MAINCOR installation system used:

MAINPRESS

MAINPEX

MAINPEXwith PE-Xc

MAINOX

Within a storey, the withdrawal locations are fully opened, starting with the withdrawal location which is furthest from the riser.

After a rinsing duration of 5 minutes at the rinsing point which was last to be opened, the withdrawal locations are closed one after the other.

The drinking water used for rinsing is filtered, resting pressure $p_w =$ _____ bar.

Maintenance fittings (shut-off facilities for individual storeys, stop valves) are fully opened.

Sensitive fittings and devices are removed and replaced by fitting pieces or bridged by flexible pipelines.

Aerators, flow limiters are removed.

Built-in dirt-collection sieves and dirt traps in front of fittings were cleaned after rinsing with water.

The rinsing took place in sections according to the rinsing order, starting from the main shut-off fitting, towards the furthest withdrawal location.

CONFIRMATION: The rinsing of the drinking water system has occurred properly.

(place, date)

(contractor signature/stamp)

(place, date)

(customer signature/stamp)

6. Tables

Pipe friction pressure drops

Pipe friction pressure drops depending on peak flow rate (cold water 10°C)

		16 x 2.0 0.11 l/meter		20 x 2.25 0.19 l/meter		25 x 2.5 0.31 l/meter		32 x 3.0 0.53 l/meter	
V_s	v	R	v	R	V_s	v	R	v	R
l/s	m/s	mbar/m	m/s	mbar/m	l/s	m/s	mbar/m	m/s	mbar/m
0.01	0.09	0.22	0.05	0.07	0.10	0.32	0.95	0.19	0.28
0.02	0.18	0.69	0.11	0.21	0.20	0.64	3.15	0.38	0.91
0.03	0.27	1.36	0.16	0.41	0.30	0.95	6.38	0.57	1.84
0.04	0.35	2.21	0.21	0.66	0.40	1.27	10.55	0.75	3.03
0.05	0.44	3.23	0.26	0.97	0.50	1.59	15.62	0.94	4.48
0.06	0.53	4.41	0.32	1.32	0.60	1.91	21.55	1.13	6.17
0.07	0.62	5.75	0.37	1.72	0.70	2.23	28.30	1.32	8.10
0.08	0.71	7.23	0.42	2.16	0.80	2.55	35.86	1.51	10.25
0.09	0.80	8.86	0.48	2.71	0.90	2.86	44.20	1.70	12.63
0.10	0.88	10.63	0.53	3.37	1.00	3.18	53.30	1.88	15.22
0.15	1.33	21.49	0.79	6.39	1.10	3.50	63.16	2.07	18.02
0.20	1.77	35.52	1.06	10.54	1.20	3.82	73.76	2.26	21.03
0.25	2.21	52.55	0.32	15.56	1.30	4.14	85.08	2.45	24.24
0.30	2.65	72.43	0.59	21.41	1.40	4.46	97.12	2.64	27.66
0.35	3.09	95.07	0.85	28.07	1.50	4.77	109.87	2.83	31.28
0.40	3.54	120.39	2.12	35.52	1.60	5.09	123.32	3.01	35.09
0.45	3.98	148.33	2.38	43.72	1.70			3.20	39.10
0.50	4.42	178.83	2.65	52.67	1.80			3.39	43.30
0.55	4.86	211.85	2.91	62.35	1.90			3.58	47.69
0.60	5.31	247.33	3.18	72.74	2.00			3.77	52.27
0.65	5.75	285.24	3.44	83.84	2.10			3.96	57.04
0.70	6.19	325.56	3.71	95.64	2.20			4.14	61.99
0.75	6.63	368.25	3.97	108.13	2.30			4.33	67.13
0.80	7.07	413.27	4.24	121.29	2.40			4.52	72.45
0.85			4.50	135.12	2.50			4.71	77.96
0.90			4.77	149.62	2.60			4.90	83.64
0.95			5.03	164.77	2.70			5.09	89.50
1.00			5.30	180.57					
1.05			5.56	197.02					
1.10			5.83	214.11					
1.15			6.09	231.84					
1.20			6.36	250.19					
1.25			6.62	269.17					
1.30			6.89	288.77					
1.35			7.15	308.99					

- V_s Peak flow rate in litres/second in accordance with DIN 1988-300
 v Flow velocity in metres/second
 R Pipe friction pressure drops in millibars/metre (1 mbar = 1 hPa)

40 x 4.0 0.8 l/meter			50 x 4.5 1.32 l/meter	
V _s	v	R	v	R
l/s	m/s	mbar/m	m/s	mbar/m
0.10	0.12	0.10	0.08	0.03
0.20	0.25	0.34	0.15	0.11
0.30	0.37	0.69	0.23	0.21
0.40	0.50	1.13	0.30	0.35
0.50	0.62	1.67	0.38	0.52
0.60	0.75	2.30	0.45	0.71
0.70	0.87	3.01	0.53	0.93
0.80	0.99	3.81	0.61	1.17
0.90	1.12	4.69	0.68	1.44
1.00	1.24	5.65	0.76	1.73
1.10	1.37	6.69	0.83	2.05
1.20	1.49	7.80	0.91	2.39
1.30	1.62	8.99	0.98	2.76
1.40	1.74	10.25	1.06	3.14
1.50	1.87	11.59	1.14	3.55
1.60	1.99	13.00	1.21	3.98
1.70	2.11	14.48	1.29	4.43
1.80	2.24	16.03	1.36	4.90
1.90	2.36	17.65	1.44	5.40
2.00	2.49	19.34	1.51	5.91
2.10	2.61	21.10	1.59	6.45
2.20	2.74	22.92	1.67	7.00
2.30	2.86	24.82	1.74	7.58
2.40	2.98	26.78	1.82	8.18
2.50	3.11	28.81	1.89	8.79
2.60	3.23	30.90	1.97	9.43
2.70	3.36	33.06	2.05	10.09
2.80	3.48	35.28	2.12	10.76
2.90	3.61	37.57	2.20	11.46
3.00	3.73	39.93	2.27	12.17
3.50	4.35	52.65	2.65	16.04
4.00	4.97	66.93	3.03	20.37
4.50	5.60	82.73	3.41	25.17
5.00			3.79	30.41
5.50			4.17	36.09
6.00			4.54	42.22
6.50			4.92	48.77
7.00			5.30	55.74
7.50			5.68	63.13
8.00			6.06	70.94
8.50			6.44	79.16
9.00			6.82	87.78

63 x 6.0 2.04 l/meter		
V _s	v	R
l/s	m/s	mbar/m
1.00	0.49	0.61
1.25	0.61	0.91
1.50	0.73	1.25
1.75	0.86	1.65
2.00	0.98	2.08
2.25	1.10	2.57
2.50	1.22	3.10
2.75	1.35	3.67
3.00	1.47	4.28
3.25	1.59	4.94
3.50	1.71	5.64
3.75	1.84	6.38
4.00	1.96	7.16
4.25	2.08	7.98
4.50	2.20	8.84
4.75	2.33	9.73
5.00	2.45	10.67
6.00	2.94	14.80
7.00	3.43	19.53
8.00	3.92	24.84
9.00	4.41	30.71
10.00	4.90	37.15
11.00	5.38	44.13

- V_s Peak flow rate in litres/second in accordance with DIN 1988-300
v Flow velocity in metres/second
R Pipe friction pressure drops in millibars/metre (1 mbar = 1 hPa)

Pipe friction pressure drops for water depending on mass flow at average water temperature of 50°C and a spread of 10k (55°C/45°C)

16 x 2,0 0,11 l/meter			20 x 2,25 0,19 l/meter		25 x 2,5 0,31 l/meter			32 x 3,0 0,53 l/meter	
V _s l/s	v m/s	R mbar/m	v m/s	R mbar/m	V _s l/s	v m/s	R mbar/m	v m/s	R mbar/m
0,01	0,09	0,09	0,05	0,03	0,10	0,32	0,71	0,19	0,21
0,02	0,18	0,50	0,11	0,15	0,20	0,64	2,41	0,38	0,69
0,03	0,27	1,00	0,16	0,30	0,30	0,95	4,94	0,57	1,41
0,04	0,35	1,64	0,21	0,49	0,40	1,27	8,24	0,75	2,35
0,05	0,44	2,41	0,26	0,72	0,50	1,59	12,30	0,94	3,49
0,06	0,53	3,31	0,32	0,98	0,60	1,91	17,00	1,13	4,83
0,07	0,62	4,33	0,37	1,29	0,70	2,23	22,40	1,32	6,37
0,08	0,71	5,48	0,42	1,62	0,80	2,55	28,50	1,51	8,08
0,09	0,80	6,73	0,48	1,99	0,90	2,86	35,20	1,70	9,98
0,10	0,88	8,10	0,53	2,40	1,00	3,18	42,50	1,88	12,10
0,15	1,33	16,60	0,79	4,89	1,10	3,50	50,50	2,07	14,30
0,20	1,77	27,60	1,06	8,13	1,20	3,82	59,10	2,26	16,70
0,25	2,21	41,10	1,32	12,10	1,30	4,14	68,30	2,45	19,30
0,30	2,65	56,90	1,59	16,70	1,40	4,46	78,10	2,64	22,10
0,35	3,09	75,00	1,85	22,00	1,50	4,77	88,50	2,83	25,00
0,40	3,54	95,30	2,12	27,90	1,60	5,09	99,50	3,01	28,10
0,45	3,98	117,80	2,38	34,50	1,70	5,41	111,10	3,20	31,40
0,50	4,42	142,40	2,65	41,60	1,80	5,73	132,30	3,39	34,80
0,55	4,86	169,10	2,91	49,40	1,90	6,05	136,00	3,58	38,40
0,60	5,31	197,90	3,18	57,80	2,00	6,37	149,30	3,77	42,0
0,65	5,75	228,70	3,44	66,70	2,10	6,68	163,10	3,96	46,00
0,70	6,19	261,60	3,71	76,20	2,20	7,00	177,60	4,14	50,00
0,75	6,63	296,40	3,97	86,30	2,30			4,33	54,20
0,80	7,07	333,20	4,24	97,00	2,40			4,52	58,60
0,85			4,50	108,20	2,50			4,71	63,10
0,90			4,77	120,00	2,60			4,90	67,70
0,95			5,03	132,30	2,70			5,09	72,60
1,00			5,30	145,20	2,80			5,27	77,50
1,05			5,56	158,60	2,90			5,46	82,60
1,10			5,83	172,60	3,00			5,65	87,90
1,15			6,09	187,10	3,50			6,59	116,40
1,20			6,36	202,10					
1,25			6,62	217,60					
1,30			6,89	233,70					
1,35			7,15	250,30					

40 x 4,0 0,8 l/meter			50 x 4,5 1,32 l/meter	
V _s	v	R	v	R
l/s	m/s	mbar/m	m/s	mbar/m
0,10	0,12	0,08	0,08	0,02
0,20	0,25	0,26	0,15	0,08
0,30	0,37	0,53	0,23	0,16
0,40	0,50	0,87	0,30	0,27
0,50	0,62	1,29	0,38	0,40
0,60	0,75	1,79	0,45	0,55
0,70	0,87	2,36	0,53	0,72
0,80	0,99	2,99	0,61	0,91
0,90	1,12	3,69	0,68	1,13
1,00	1,24	4,45	0,76	1,36
1,10	1,37	5,28	0,83	1,61
1,20	1,49	6,18	0,91	1,88
1,30	1,62	7,13	0,98	2,17
1,40	1,74	8,15	1,06	2,48
1,50	1,87	9,22	1,14	2,81
1,60	1,99	10,40	1,21	3,15
1,70	2,11	11,60	1,29	3,51
1,80	2,24	12,80	1,36	3,89
1,90	2,36	14,10	1,44	4,29
2,00	2,49	15,50	1,51	4,71
2,10	2,61	16,90	1,59	5,14
2,20	2,74	18,40	1,67	5,59
2,30	2,86	19,90	1,74	6,05
2,40	2,98	21,50	1,82	6,53
2,50	3,11	23,20	1,89	7,03
2,60	3,23	24,90	1,97	7,55
2,70	3,36	26,70	2,05	8,08
2,80	3,48	28,50	2,12	8,63
2,90	3,61	30,30	2,20	9,20
3,00	3,73	32,30	2,27	9,78
3,50	4,35	42,70	2,65	12,90
4,00	4,97	54,40	3,03	16,50
4,50	5,60	67,40	3,41	20,40
5,00	6,22	81,70	3,79	24,70
5,50	6,84	97,30	4,17	29,40
6,00	7,46	144,00	4,54	34,40
6,50			4,92	39,80
7,00			5,30	45,60
7,50			5,68	51,70
8,00			6,06	58,10
8,50			6,44	65,00
9,00			6,82	72,10

63 x 6,0 2,04 l/meter		
V _s	v	R
l/s	m/s	mbar/m
1,00	0,49	0,48
1,20	0,59	0,66
1,40	0,69	0,87
1,60	0,78	1,11
1,80	0,88	1,37
2,00	0,98	1,65
2,20	1,08	1,96
2,40	1,17	2,29
2,60	1,27	2,64
2,80	1,37	3,02
3,00	1,47	3,42
3,50	1,71	4,52
4,00	1,96	5,75
4,50	2,20	7,12
5,00	2,45	8,62
6,00	2,94	12,00
7,00	3,43	15,90
8,00	3,92	20,20
9,00	4,41	25,10
10,00	4,90	30,40
11,00	5,38	36,20
12,00	5,87	42,50
13,00	6,36	49,20
14,00	6,85	56,30
15,00	7,34	63,90

Pipe friction pressure drops for water depending on mass flow at average water temperature of 47,5°C and a spread of 5k (50°C/ 45°C)

16 x 2,0 0,111/m				20 x 2,25 0,19 l/m				25 x 2,5 0,311/m			
Q	m	v	R	Q	m	v	R	Q	m	v	R
W	kg/h	m/s	Pa/m	W	kg/h	m/s	Pa/m	W	kg/h	m/s	Pa/m
200	34	0,09	16	400	69	0,10	15	400	69	0,06	5
250	43	0,11	23	600	103	0,15	30	600	103	0,09	9
300	52	0,13	31	800	138	0,21	49	800	138	0,12	15
350	60	0,15	40	1000	172	0,26	72	1000	172	0,15	22
400	69	0,17	50	1200	207	0,31	98	1200	207	0,18	29
450	78	0,19	61	1400	241	0,36	128	1400	241	0,22	38
500	86	0,21	73	1600	276	0,41	162	1600	276	0,25	48
550	95	0,24	86	1800	310	0,46	199	1800	310	0,28	59
600	103	0,26	100	2000	344	0,51	239	2000	344	0,31	71
650	112	0,28	115	2200	379	0,56	282	2200	379	0,34	84
700	121	0,30	130	2400	413	0,62	329	2400	413	0,37	98
750	129	0,32	146	2600	448	0,67	378	2600	448	0,40	113
800	138	0,34	164	2800	482	0,72	431	2800	482	0,43	128
850	146	0,36	182	3000	517	0,77	486	3000	517	0,46	145
900	155	0,39	201	3200	551	0,82	545	3200	551	0,49	162
950	164	0,41	220	3400	586	0,87	606	3400	586	0,52	180
1000	172	0,43	241	3600	620	0,92	670	3600	620	0,55	199
1050	181	0,45	262	3800	655	0,97	737	3800	655	0,59	219
1100	189	0,47	284	4000	689	1,03	807	4000	689	0,62	240
1150	198	0,49	307					4200	723	0,65	261
1200	207	0,51	330					4400	758	0,68	283
1250	215	0,53	355					4600	792	0,71	306
1300	224	0,56	380					4800	827	0,74	330
1350	233	0,58	406					5000	861	0,77	355
1400	241	0,60	432					5200	896	0,80	380
1450	250	0,62	459					5400	930	0,83	407
1500	258	0,64	487					5600	965	0,86	434
1550	267	0,66	516					5800	999	0,89	461
1600	276	0,68	546					6000	1033	0,92	490
1650	284	0,71	576					6500	1120	1,00	564
1700	293	0,73	607					7000	1206	1,08	643
1750	301	0,75	638					7500	1292	1,16	727
1800	310	0,77	670					8000	1378	1,23	815
1850	319	0,79	703					8500	1464	1,31	908
1900	327	0,81	737					9000	1550	1,39	1005
1950	336	0,83	771					9500	1636	1,46	1107
2000	344	0,86	806					10000	1722	1,54	1213
2100	362	0,90	878								
2200	379	0,94	953								
2300	396	0,98	1030								
2400	413	1,03	1111								

32 x 3,0
0,53 l/m

Q	m	v	R
W	kg/h	m/s	Pa/m
400	69	0,04	1
600	103	0,05	3
800	138	0,07	4
1000	172	0,09	6
1200	207	0,11	9
1400	241	0,13	11
1600	276	0,15	14
1800	310	0,16	17
2000	344	0,18	21
2200	379	0,20	24
2400	413	0,22	28
2600	448	0,24	32
2800	482	0,26	37
3000	517	0,27	42
3200	551	0,29	47
3400	586	0,31	52
3600	620	0,33	57
3800	655	0,35	63
4000	689	0,36	69
4200	723	0,38	75
4400	758	0,40	81
4600	792	0,42	88
4800	827	0,44	95
5000	861	0,46	102
5200	896	0,47	109
5400	930	0,49	116
5600	965	0,51	124
5800	999	0,53	132
6000	1033	0,55	140
6500	1120	0,59	161
7000	1206	0,64	184
7500	1292	0,68	208
8000	1378	0,73	233
8500	1464	0,77	259
9000	1550	0,82	287
9500	1636	0,87	316
10000	1722	0,91	346
10500	1809	0,96	377
11000	1895	1,00	410
11500	1981	1,05	443
12000	2067	1,09	478
12500	2153	1,14	514
13000	2239	1,18	551
13500	2325	1,23	590
14000	2411	1,28	629
14500	2498	1,32	670
15000	2584	1,37	712
15500	2670	1,41	755
16000	2756	1,46	799
16500	2842	1,50	844

40 x 4,0
0,80 l/m

Q	m	v	R
W	kg/h	m/s	Pa/m
4000	689	0,24	26
5000	861	0,30	38
6000	1033	0,36	52
7000	1206	0,42	68
8000	1378	0,48	87
9000	1550	0,54	107
10000	1722	0,60	128
11000	1895	0,66	152
12000	2067	0,72	177
13000	2239	0,78	204
14000	2411	0,84	233
15000	2584	0,90	264
16000	2756	0,96	296
17000	2928	1,02	329
18000	3100	1,08	365
19000	3273	1,14	402
20000	3445	1,20	440
22000	3789	1,32	522
24000	4134	1,44	610
26000	4478	1,56	704

50 x 4,5
1,32 l/m

Q	m	v	R
W	kg/h	m/s	Pa/m
4000	689	0,15	8
5000	861	0,18	12
6000	1033	0,22	16
7000	1206	0,26	21
8000	1378	0,29	27
9000	1550	0,33	33
10000	1722	0,37	39
11000	1895	0,40	47
12000	2067	0,44	54
13000	2239	0,48	63
14000	2411	0,51	71
15000	2584	0,55	81
16000	2756	0,59	90
17000	2928	0,62	101
18000	3100	0,66	111
19000	3273	0,70	123
20000	3445	0,73	134
22000	3789	0,81	159
24000	4134	0,88	186
26000	4478	0,95	215
28000	4823	1,03	245
30000	5167	1,10	277
32000	5512	1,17	311
34000	5856	1,25	347
36000	6201	1,32	384
38000	6545	1,39	423
40000	6890	1,47	464
42000	7234	1,54	506

63 x 6,0
2,04 l/m

Q	m	v	R
W	kg/h	m/s	Pa/m
4000	689	0,09	3
5000	861	0,12	4
6000	1033	0,14	6
7000	1206	0,17	7
8000	1378	0,19	9
9000	1550	0,21	12
10000	1722	0,24	14
11000	1895	0,26	16
12000	2067	0,28	19
13000	2239	0,31	22
14000	2411	0,33	25
15000	2584	0,36	28
16000	2756	0,38	32
17000	2928	0,40	36
18000	3100	0,43	39
19000	3273	0,45	43
20000	3445	0,47	47
22000	3789	0,52	56
24000	4134	0,57	66
26000	4478	0,62	76
28000	4823	0,66	86
30000	5167	0,71	97
32000	5512	0,76	109
34000	5856	0,81	122
36000	6201	0,85	135
38000	6545	0,90	149
40000	6890	0,95	163
42000	7234	0,99	178
44000	7579	1,04	193
46000	7923	1,09	209
48000	8268	1,14	226
50000	8612	1,18	243
52000	8957	1,23	261
54000	9301	1,28	279
56000	9646	1,33	298
58000	9990	1,37	317
60000	10335	1,42	337
62000	10679	1,47	358
64000	11024	1,52	379
66000	11368	1,56	400
68000	11713	1,61	422
70000	12057	1,66	445
72000	12402	1,71	468
74000	12746	1,75	492
76000	13091	1,80	516
78000	13435	1,85	541
80000	13780	1,90	566
82000	14124	1,94	592
84000	14469	1,99	618
86000	14813	2,04	645

16 x 2,0
0,11 l/m

20 x 2,25
0,19 l/m

25 x 2,5
0,31 l/m

Q	m	v	R	Q	m	v	R	Q	m	v	R
W	kg/h	m/s	Pa/m	W	kg/h	m/s	Pa/m	W	kg/h	m/s	Pa/m
200	17	0,04	5	500	43	0,06	7	500	43	0,04	2
300	26	0,06	9	1000	86	0,13	22	1000	86	0,08	7
400	34	0,09	15	1500	129	0,19	43	1500	129	0,12	13
500	43	0,11	22	2000	172	0,26	71	2000	172	0,15	21
600	52	0,13	30	2500	215	0,32	104	2500	215	0,19	31
700	60	0,15	39	3000	258	0,39	143	3000	258	0,23	43
800	69	0,17	49	3500	301	0,45	188	3500	301	0,27	56
900	78	0,19	60	4000	344	0,51	237	4000	344	0,31	71
1000	86	0,21	72	4500	388	0,58	291	4500	388	0,35	87
1100	95	0,24	85	5000	431	0,64	350	5000	431	0,39	104
1200	103	0,26	99	5500	474	0,71	414	5500	474	0,42	123
1300	112	0,28	113	6000	517	0,77	482	6000	517	0,46	143
1400	121	0,30	129	6500	560	0,83	555	6500	560	0,50	165
1500	129	0,32	145	7000	603	0,90	632	7000	603	0,54	188
1600	138	0,34	162	7500	646	0,96	714	7500	646	0,58	212
1700	146	0,36	180	8000	689	1,03	800	8000	689	0,62	237
1800	155	0,39	199					8500	732	0,66	264
1900	164	0,41	218					9000	775	0,69	292
2000	172	0,43	238					9500	818	0,73	321
2100	181	0,45	259					10000	861	0,77	352
2200	189	0,47	281					10500	904	0,81	383
2300	198	0,49	304					11000	947	0,85	416
2400	207	0,51	327					11500	990	0,89	450
2500	215	0,54	351					12000	1033	0,93	486
2600	224	0,56	376					12500	1077	0,96	522
2700	233	0,58	402					13000	1120	1,00	560
2800	241	0,60	428					13500	1163	1,04	598
2900	250	0,62	455					14000	1206	1,08	638
3000	258	0,64	483					14500	1249	1,12	679
3200	276	0,69	540					15000	1292	1,16	721
3400	293	0,73	601					16000	1378	1,23	809
3600	310	0,77	664					17000	1464	1,31	901
3800	327	0,81	730					18000	1550	1,39	997
4000	344	0,86	799					19000	1636	1,47	1098
4200	362	0,90	870					20000	1722	1,54	1203
4400	379	0,94	945								
4600	396	0,99	1021								
4800	413	1,03	1101								

32 x 3,0
0,53 l/m

Q	m	v	R
W	kg/h	m/s	Pa/m
500	43	0,02	1
1000	86	0,05	2
1500	129	0,07	4
2000	172	0,09	6
2500	215	0,11	9
3000	258	0,14	12
3500	301	0,16	16
4000	344	0,18	20
4500	388	0,21	25
5000	431	0,23	30
5500	474	0,25	35
6000	517	0,27	41
6500	560	0,30	47
7000	603	0,32	54
7500	646	0,34	61
8000	689	0,37	68
8500	732	0,39	76
9000	775	0,41	84
9500	818	0,43	92
10000	861	0,46	101
10500	904	0,48	110
11000	947	0,50	119
11500	990	0,52	129
12000	1033	0,55	139
12500	1077	0,57	149
13000	1120	0,59	160
13500	1163	0,62	171
14000	1206	0,64	182
14500	1249	0,66	194
15000	1292	0,68	206
16000	1378	0,73	231
17000	1464	0,78	257
18000	1550	0,82	285
19000	1636	0,87	313
20000	1722	0,91	343
21000	1809	0,96	374
22000	1895	1,00	406
23000	1981	1,05	440
24000	2067	1,10	474
25000	2153	1,14	510
26000	2239	1,19	547
27000	2325	1,23	585
28000	2411	1,28	624
29000	2498	1,32	665
30000	2584	1,37	706
31000	2670	1,41	749
32000	2756	1,46	792
33000	2842	1,51	837
34000	2928	1,55	883
35000	3014	1,60	930

40 x 4,0
0,80 l/m

Q	m	v	R
W	kg/h	m/s	Pa/m
2000	172	0,06	2
4000	344	0,12	8
6000	517	0,18	15
8000	689	0,24	25
10000	861	0,30	38
12000	1033	0,36	52
14000	1206	0,42	68
16000	1378	0,48	86
18000	1550	0,54	106
20000	1722	0,60	127
22000	1895	0,66	151
24000	2067	0,72	176
26000	2239	0,78	203
28000	2411	0,84	231
30000	2584	0,90	261
32000	2756	0,96	293
34000	2928	1,02	327
36000	3100	1,08	362
38000	3273	1,14	398
40000	3445	1,20	437
42000	3617	1,27	476
44000	3789	1,33	518
46000	3962	1,39	561
48000	4134	1,45	605
50000	4306	1,51	651

63 x 6
2,04 l/m

Q	m	v	R
W	kg/h	m/s	Pa/m
2000	172	0,02	1
4000	344	0,05	1
6000	517	0,07	2
8000	689	0,09	3
10000	861	0,12	4
12000	1033	0,14	6
14000	1206	0,17	7
16000	1378	0,19	9
18000	1550	0,21	11
20000	1722	0,24	14
22000	1895	0,26	16
24000	2067	0,28	19
26000	2239	0,31	22
28000	2411	0,33	25
30000	2584	0,36	28
32000	2756	0,38	32
34000	2928	0,40	35
36000	3100	0,43	39
38000	3273	0,45	43
40000	3445	0,47	47
42000	3617	0,50	51
44000	3789	0,52	56
46000	3962	0,55	60
48000	4134	0,57	65
50000	4306	0,59	70
55000	4737	0,65	83
60000	5167	0,71	97
65000	5598	0,77	112
70000	6029	0,83	127
75000	6459	0,89	144
80000	6890	0,95	162
85000	7321	1,01	180
90000	7751	1,07	200
95000	8182	1,13	220
100000	8612	1,19	241
105000	9043	1,25	263
110000	9474	1,30	286
115000	9904	1,36	310
120000	10335	1,42	335
125000	10766	1,48	360
130000	11196	1,54	387
135000	11627	1,60	414
140000	12057	1,66	442
145000	12488	1,72	471
150000	12919	1,78	500
155000	13349	1,84	531
160000	13780	1,90	562
165000	14211	1,96	594
170000	14641	2,02	627
175000	15072	2,08	661

50 x 4,5
1,32 l/m

Q	m	v	R
W	kg/h	m/s	Pa/m
2000	172	0,04	1
4000	344	0,07	2
6000	517	0,11	5
8000	689	0,15	8
10000	861	0,18	12
12000	1033	0,22	16
14000	1206	0,26	21
16000	1378	0,29	26
18000	1550	0,33	32
20000	1722	0,37	39
22000	1895	0,40	46
24000	2067	0,44	54
26000	2239	0,48	62
28000	2411	0,51	71
30000	2584	0,55	80
32000	2756	0,59	90
34000	2928	0,62	100
36000	3100	0,66	111
38000	3273	0,70	122
40000	3445	0,73	133
42000	3617	0,77	145
44000	3789	0,81	158
46000	3962	0,84	171
48000	4134	0,88	185
50000	4306	0,92	199
55000	4737	1,01	235
60000	5167	1,10	275
65000	5598	1,19	317
70000	6029	1,28	362
75000	6459	1,38	410
80000	6890	1,47	461
85000	7321	1,56	514

Pipe friction pressure drops for water depending on mass flow at average water temperature of 50°C and a spread of 15k (70°C/ 55°C)

16 x 2,0 0,11 l/m			
Q	m	v	R
W	kg/h	m/s	Pa/m
200	9	0,02	1
400	17	0,04	5
600	26	0,06	9
800	34	0,09	15
1000	43	0,11	21
1200	52	0,13	29
1400	60	0,15	38
1600	69	0,17	47
1800	78	0,19	58
2000	86	0,22	69
2200	95	0,24	82
2400	103	0,26	95
2600	112	0,28	109
2800	121	0,30	124
3000	129	0,32	140
3200	138	0,34	156
3400	146	0,37	173
3600	155	0,39	192
3800	164	0,41	210
4000	172	0,43	230
4200	181	0,45	250
4400	189	0,47	271
4600	198	0,50	293
4800	207	0,52	316
5000	215	0,54	339
5200	224	0,56	363
5400	233	0,58	388
5600	241	0,60	414
5800	250	0,62	440
6000	258	0,65	467
6200	267	0,67	494
6400	276	0,69	522
6600	284	0,71	551
6800	293	0,73	581
7000	301	0,75	611
7500	323	0,81	690
8000	344	0,86	773
8500	366	0,91	860
9000	388	0,97	951
9500	409	1,02	1046

20 x 2,25 0,19 l/m			
Q	m	v	R
W	kg/h	m/s	Pa/m
1000	43	0,06	6
2000	86	0,13	21
3000	129	0,19	42
4000	172	0,26	68
5000	215	0,32	101
6000	258	0,39	138
7000	301	0,45	181
8000	344	0,52	229
9000	388	0,58	281
10000	431	0,64	338
11000	474	0,71	400
12000	517	0,77	466
13000	560	0,84	537
14000	603	0,90	612
15000	646	0,97	692
16000	689	1,03	775

25 x 2,5
0,311/m

Q	m	v	R
W	kg/h	m/s	Pa/m
1000	43	0,04	2
2000	86	0,08	6
3000	129	0,12	13
4000	172	0,15	21
5000	215	0,19	30
6000	258	0,23	41
7000	301	0,27	54
8000	344	0,31	68
9000	388	0,35	84
10000	431	0,39	101
11000	474	0,43	119
12000	517	0,46	139
13000	560	0,50	160
14000	603	0,54	182
15000	646	0,58	205
16000	689	0,62	230
17000	732	0,66	256
18000	775	0,70	283
19000	818	0,74	311
20000	861	0,77	341
21000	904	0,81	372
22000	947	0,85	404
23000	990	0,89	437
24000	1033	0,93	471
25000	1077	0,97	506
26000	1120	1,01	543
27000	1163	1,05	580
28000	1206	1,08	619
29000	1249	1,12	659
30000	1292	1,16	700
32000	1378	1,24	785
34000	1464	1,32	875
36000	1550	1,39	969
38000	1636	1,47	1067
40000	1722	1,55	1169

32 x 3,0
0,53 l/m

Q	m	v	R
W	kg/h	m/s	Pa/m
1000	43	0,02	1
2000	86	0,05	2
3000	129	0,07	4
4000	172	0,09	6
5000	215	0,11	9
6000	258	0,14	12
7000	301	0,16	16
8000	344	0,18	20
9000	388	0,21	24
10000	431	0,23	29
11000	474	0,25	34
12000	517	0,28	40
13000	560	0,30	46
14000	603	0,32	52
15000	646	0,34	59
16000	689	0,37	66
17000	732	0,39	73
18000	775	0,41	81
19000	818	0,44	89
20000	861	0,46	98
21000	904	0,48	106
22000	947	0,50	115
23000	990	0,53	125
24000	1033	0,55	135
25000	1077	0,57	145
26000	1120	0,60	155
27000	1163	0,62	166
28000	1206	0,64	177
29000	1249	0,66	188
30000	1292	0,69	200
32000	1378	0,73	224
34000	1464	0,78	249
36000	1550	0,83	276
38000	1636	0,87	304
40000	1722	0,92	333
42000	1809	0,96	363
44000	1895	1,01	395
46000	1981	1,05	427
48000	2067	1,10	461
50000	2153	1,15	496
52000	2239	1,19	532
54000	2325	1,24	569
56000	2411	1,28	607
58000	2498	1,33	646
60000	2584	1,38	686
62000	2670	1,42	728
64000	2756	1,47	770
66000	2842	1,51	814
68000	2928	1,56	859
70000	3014	1,60	905

40 x 4,0
0,80 l/m

Q	m	v	R
W	kg/h	m/s	Pa/m
10000	431	0,15	11
15000	646	0,23	22
20000	861	0,30	36
25000	1077	0,38	54
30000	1292	0,45	74
35000	1507	0,53	97
40000	1722	0,61	123
45000	1938	0,68	152
50000	2153	0,76	184
55000	2368	0,83	217
60000	2584	0,91	254
65000	2799	0,98	293
70000	3014	1,06	334
75000	3230	1,13	378
80000	3445	1,21	425
85000	3660	1,29	473
90000	3876	1,36	524
95000	4091	1,44	578
100000	4306	1,51	633

50 x 4,5
1,32 l/m

Q	m	v	R
W	kg/h	m/s	Pa/m
10000	431	0,09	3
15000	646	0,14	7
20000	861	0,18	11
25000	1077	0,23	17
30000	1292	0,28	23
35000	1507	0,32	30
40000	1722	0,37	38
45000	1938	0,41	47
50000	2153	0,46	56
55000	2368	0,51	67
60000	2584	0,55	78
65000	2799	0,60	89
70000	3014	0,65	102
75000	3230	0,69	115
80000	3445	0,74	130
85000	3660	0,78	144
90000	3876	0,83	160
95000	4091	0,88	176
100000	4306	0,92	193
105000	4522	0,97	211
110000	4737	1,01	229
115000	4952	1,06	248
120000	5167	1,11	267
125000	5383	1,15	288
130000	5598	1,20	309
135000	5813	1,24	330
140000	6029	1,29	353
145000	6244	1,34	376
150000	6459	1,38	399
160000	6890	1,47	448
170000	7321	1,57	500

63 x 6,0
2,04 l/m

Q	m	v	R
W	kg/h	m/s	Pa/m
10000	431	0,06	1
15000	646	0,09	2
20000	861	0,12	4
25000	1077	0,15	6
30000	1292	0,18	8
35000	1507	0,21	11
40000	1722	0,24	13
45000	1938	0,27	16
50000	2153	0,30	20
55000	2368	0,33	23
60000	2584	0,36	27
65000	2799	0,39	32
70000	3014	0,42	36
75000	3230	0,45	41
80000	3445	0,48	46
85000	3660	0,51	51
90000	3876	0,54	56
95000	4091	0,57	62
100000	4306	0,60	68
105000	4522	0,63	74
110000	4737	0,66	80
115000	4952	0,69	87
120000	5167	0,71	94
125000	5383	0,74	101
130000	5598	0,77	108
135000	5813	0,80	116
140000	6029	0,83	124
145000	6244	0,86	132
150000	6459	0,89	140
160000	6890	0,95	157
170000	7321	1,01	175
180000	7751	1,07	194
190000	8182	1,13	214
200000	8612	1,19	235
210000	9043	1,25	256
220000	9474	1,31	279
230000	9904	1,37	302
240000	10335	1,43	326
250000	10766	1,49	351
260000	11196	1,55	377
270000	11627	1,61	403
280000	12057	1,67	431
290000	12488	1,73	459
300000	12919	1,79	488
310000	13349	1,85	518
320000	13780	1,91	548
330000	14211	1,97	579
340000	14641	2,03	612
350000	15072	2,09	644
360000	15502	2,14	678

Pipe friction pressure drops for water depending on mass flow at average water temperature of 50°C and a spread of 20k (70°C/ 50°C)

16 x 2,0 0,11 l/m			
Q	m	v	R
W	kg/h	m/s	Pa/m
200	9	0,02	1
400	17	0,04	5
600	26	0,06	9
800	34	0,09	15
1000	43	0,11	21
1200	52	0,13	29
1400	60	0,15	38
1600	69	0,17	47
1800	78	0,19	58
2000	86	0,22	69
2200	95	0,24	82
2400	103	0,26	95
2600	112	0,28	109
2800	121	0,30	124
3000	129	0,32	140
3200	138	0,34	156
3400	146	0,37	173
3600	155	0,39	192
3800	164	0,41	210
4000	172	0,43	230
4200	181	0,45	250
4400	189	0,47	271
4600	198	0,50	293
4800	207	0,52	316
5000	215	0,54	339
5200	224	0,56	363
5400	233	0,58	388
5600	241	0,60	414
5800	250	0,62	440
6000	258	0,65	467
6200	267	0,67	494
6400	276	0,69	522
6600	284	0,71	551
6800	293	0,73	581
7000	301	0,75	611
7500	323	0,81	690
8000	344	0,86	773
8500	366	0,91	860
9000	388	0,97	951
9500	409	1,02	1046

20 x 2,25 0,19 l/m			
Q	m	v	R
W	kg/h	m/s	Pa/m
1000	43	0,06	6
2000	86	0,13	21
3000	129	0,19	42
4000	172	0,26	68
5000	215	0,32	101
6000	258	0,39	138
7000	301	0,45	181
8000	344	0,52	229
9000	388	0,58	281
10000	431	0,64	338
11000	474	0,71	400
12000	517	0,77	466
13000	560	0,84	537
14000	603	0,90	612
15000	646	0,97	692
16000	689	1,03	775

25 x 2,5 0,31 l/m			
Q	m	v	R
W	kg/h	m/s	Pa/m
1000	43	0,04	2
2000	86	0,08	6
3000	129	0,12	13
4000	172	0,15	21
5000	215	0,19	30
6000	258	0,23	41
7000	301	0,27	54
8000	344	0,31	68
9000	388	0,35	84
10000	431	0,39	101
11000	474	0,43	119
12000	517	0,46	139
13000	560	0,50	160
14000	603	0,54	182
15000	646	0,58	205
16000	689	0,62	230
17000	732	0,66	256
18000	775	0,70	283
19000	818	0,74	311
20000	861	0,77	341
21000	904	0,81	372
22000	947	0,85	404
23000	990	0,89	437
24000	1033	0,93	471
25000	1077	0,97	506
26000	1120	1,01	543
27000	1163	1,05	580
28000	1206	1,08	619
29000	1249	1,12	659
30000	1292	1,16	700
32000	1378	1,24	785
34000	1464	1,32	875
36000	1550	1,39	969
38000	1636	1,47	1067
40000	1722	1,55	1169

32 x 3,0
0,53 l/m

Q	m	v	R
W	kg/h	m/s	Pa/m
1000	43	0,02	1
2000	86	0,05	2
3000	129	0,07	4
4000	172	0,09	6
5000	215	0,11	9
6000	258	0,14	12
7000	301	0,16	16
8000	344	0,18	20
9000	388	0,21	24
10000	431	0,23	29
11000	474	0,25	34
12000	517	0,28	40
13000	560	0,30	46
14000	603	0,32	52
15000	646	0,34	59
16000	689	0,37	66
17000	732	0,39	73
18000	775	0,41	81
19000	818	0,44	89
20000	861	0,46	98
21000	904	0,48	106
22000	947	0,50	115
23000	990	0,53	125
24000	1033	0,55	135
25000	1077	0,57	145
26000	1120	0,60	155
27000	1163	0,62	166
28000	1206	0,64	177
29000	1249	0,66	188
30000	1292	0,69	200
32000	1378	0,73	224
34000	1464	0,78	249
36000	1550	0,83	276
38000	1636	0,87	304
40000	1722	0,92	333
42000	1809	0,96	363
44000	1895	1,01	395
46000	1981	1,05	427
48000	2067	1,10	461
50000	2153	1,15	496
52000	2239	1,19	532
54000	2325	1,24	569
56000	2411	1,28	607
58000	2498	1,33	646
60000	2584	1,38	686
62000	2670	1,42	728
64000	2756	1,47	770
66000	2842	1,51	814
68000	2928	1,56	859
70000	3014	1,60	905

40 x 4,0
0,80 l/m

Q	m	v	R
W	kg/h	m/s	Pa/m
10000	431	0,15	11
15000	646	0,23	22
20000	861	0,30	36
25000	1077	0,38	54
30000	1292	0,45	74
35000	1507	0,53	97
40000	1722	0,61	123
45000	1938	0,68	152
50000	2153	0,76	184
55000	2368	0,83	217
60000	2584	0,91	254
65000	2799	0,98	293
70000	3014	1,06	334
75000	3230	1,13	378
80000	3445	1,21	425
85000	3660	1,29	473
90000	3876	1,36	524
95000	4091	1,44	578
100000	4306	1,51	633

50 x 4,5
1,32 l/m

Q	m	v	R
W	kg/h	m/s	Pa/m
10000	431	0,09	3
15000	646	0,14	7
20000	861	0,18	11
25000	1077	0,23	17
30000	1292	0,28	23
35000	1507	0,32	30
40000	1722	0,37	38
45000	1938	0,41	47
50000	2153	0,46	56
55000	2368	0,51	67
60000	2584	0,55	78
65000	2799	0,60	89
70000	3014	0,65	102
75000	3230	0,69	115
80000	3445	0,74	130
85000	3660	0,78	144
90000	3876	0,83	160
95000	4091	0,88	176
100000	4306	0,92	193
105000	4522	0,97	211
110000	4737	1,01	229
115000	4952	1,06	248
120000	5167	1,11	267
125000	5383	1,15	288
130000	5598	1,20	309
135000	5813	1,24	330
140000	6029	1,29	353
145000	6244	1,34	376
150000	6459	1,38	399
160000	6890	1,47	448
170000	7321	1,57	500

63 x 6,0
2,04 l/m

Q	m	v	R
W	kg/h	m/s	Pa/m
10000	431	0,06	1
15000	646	0,09	2
20000	861	0,12	4
25000	1077	0,15	6
30000	1292	0,18	8
35000	1507	0,21	11
40000	1722	0,24	13
45000	1938	0,27	16
50000	2153	0,30	20
55000	2368	0,33	23
60000	2584	0,36	27
65000	2799	0,39	32
70000	3014	0,42	36
75000	3230	0,45	41
80000	3445	0,48	46
85000	3660	0,51	51
90000	3876	0,54	56
95000	4091	0,57	62
100000	4306	0,60	68
105000	4522	0,63	74
110000	4737	0,66	80
115000	4952	0,69	87
120000	5167	0,71	94
125000	5383	0,74	101
130000	5598	0,77	108
135000	5813	0,80	116
140000	6029	0,83	124
145000	6244	0,86	132
150000	6459	0,89	140
160000	6890	0,95	157
170000	7321	1,01	175
180000	7751	1,07	194
190000	8182	1,13	214
200000	8612	1,19	235
210000	9043	1,25	256
220000	9474	1,31	279
230000	9904	1,37	302
240000	10335	1,43	326
250000	10766	1,49	351
260000	11196	1,55	377
270000	11627	1,61	403
280000	12057	1,67	431
290000	12488	1,73	459
300000	12919	1,79	488
310000	13349	1,85	518
320000	13780	1,91	548
330000	14211	1,97	579
340000	14641	2,03	612
350000	15072	2,09	644
360000	15502	2,14	678

7. Standards

The applicable standards and directives for the heating and sanitary installation are shown in the following table. Only the most important reference DIN standards, requirements, regulations and ordinances are listed:

Standards and directives	Meaning
DIN 1988-100	Technical regulations for drinking water installations, protection of the drinking water, maintenance of the drinking water quality - DVGW Technical Regulations
DIN 1988-200	Technical regulations for drinking water installations, installation type A (closed systems), planning, components, devices, materials - DVGW Technical Regulations
DIN 1988-300	Regulations for drinking water installations, determination of pipe diameter, DVGW Technical Regulations
DIN 1988-600	Technical regulations for drinking water installations (TRWI) Part 6: Fire extinguishing and fire protection systems - DVGW Technical Regulations
DIN 2000	Central drinking water supply - guidelines for arrangements for drinking water, planning, construction, operation and maintenance of the supply systems - DVGW Technical Regulations
DIN 4703	Radiators
DIN 4721	Plastic pipeline systems for hot water underfloor heating and radiator connection - polyethylene of raised temperature resistance
DIN 4725-200	Hot water underfloor heating systems and components - Part 200: Provisions of the heat output (pipe covering < greater > 0.065m)
DIN EN 806-1	Technical regulations for drinking water installations - Part 1: General; German version EN 806-1:2001 + A1:2001
DIN EN 806-2	Technical regulations for drinking water installations - Part 2 Planning; German version EN 806-2:2005
DIN EN 12828	Heating systems in buildings - planning of hot water heating systems; German version EN 12828:2003
DIN EN 14336	Heating systems in buildings - installation and approval of hot water heating systems; German version EN 14336:2004
DIN 4726	Hot water surface heating systems and radiator connections - plastic pipeline and multi-layer pipeline systems
DIN EN 12831	Heating systems in buildings - method for calculating the standard heating load
DIN EN 1264	Room surface-integrated heating and cooling systems with water flow
DIN 18560	Floor screeds in building construction
DIN 30660	Sealants for the gas and water supply as well as for water heating systems - non-hardening sealants and polytetrafluoroethylene (PTFE- bands for metallic thread connections of domestic installation)
DIN 18380	VOB Construction Tendering and Contract Regulation - Part C: General technical contractual obligations for construction work (ATV) - heating systems and central water heating systems
DIN EN 12170	Heating systems in buildings - maintenance and operating manuals - heating systems which require qualified operating personnel
VDI/DVGW 6023	Hygiene in drinking water installations; Requirements for planning, execution, operation and maintenance
DIN EN 804	Plastic pipeline systems - injection moulding pieces with adhesive collar connections for pressure pipelines - testing method for resistance against hydrostatic short-term internal pressure; German version EN 804:1994
DIN EN 1717	Protection of the drinking water from impurities in drinking water installations and general requirements for safety devices for the prevention of drinking water impurities by backflow; German version EN 1717:2000; DVGW Technical Regulation

8. Certificates and guarantees



CERTIFICATE

Extended Warranty

We herewith confirm the extension of the warranty for DVGW certified components (pipe and fittings) for the MAINPEX SLIDING SLEEVE SYSTEM (DW-8501BS0475) AND MAINPRESS SYSTEM (DW-8501BU0326).

For a period of **10 years**, we will provide replacement for:

- 1) MAINCOR pipe systems MAINPEX (MPX), MAINPRESS (MPR) and MAINPIPE in the event of damage that is demonstrably due to defects in production or material, as far as the manufacturer is held responsible.
- 2) Damage that is caused by production defects to the property of third parties and any resulting consequential losses.
- 3) Expenses of third parties caused by removing, dismounting, disassembly and clearing of defective products as well as for mounting and laying non-defective products to be supplied by us.

The warranty extends to all above mentioned system components such as pipes and fittings insofar as supplied by us. No warranty is granted for laying and installation errors. The technical documentation and application guidelines shall be decisive.

For coverage, there is an extended product liability insurance with a renowned German insurance company with the following sums insured:

- 3.000.000,- EUR lump-sum, for bodily injury as well as economic losses of property and product
- 2.000.000,- EUR maximum sum for an individual person

Schweinfurt, August 1, 2019



Dieter Pfister
Managing director



Michael Pfister
Managing director

ROHRSYSTEME
MADE IN
GERMANY



CERTIFICATE

Compatibility with mixed-composite pipe systems

Our MAINPRESS Pressing-System (DVGW BU0326) with the MAINPIPE multilayer composite pipe PE-RT/AL/PE-RT (DVGW BU0016) is compatible with:

- Composite pipe UPONOR-UNIPIPE MLC with press fittings MLC (Verarbeitung Fitting S-Press Plus nur mit freigegebener Pressbacke)
- Composite pipe WAVIN with press fittings K1 and M1
- Composite pipe MULTITUBO with press fittings MT
- Composite pipe Jupiter-Perfekt Aqua with press fittings MP/KF
- Composite pipe COES with COES press fittings for press contour U (KSP5)
- Commercially-available press tools with press contour U (KSP5)

Should leakage occur among the mentioned single components and the MAINPRESS System, MAINCOR will determine the error reason and assume warranty if the third-party products are technically impeccable and their processing has been made in accordance with our mounting and laying guidelines.

Legal warranty of the respective manufacturer for the products in circulation remains unchanged.

Schweinfurt, August 1, 2019

Dieter Pfister
Managing director

Michael Pfister
Managing director



CERT

DVGW-Baumusterprüfzertifikat

DVGW type examination certificate

DW-8501BU0326

Registriernummer
registration number

Anwendungsbereich <i>field of application</i>	Produkte der Wasserversorgung <i>products of water supply</i>
Zertifikatinhaber <i>owner of certificate</i>	Maincor Rohrsysteme GmbH & Co. KG Silbersteinstraße 14, D-97424 Schweinfurt
Vertreiber <i>distributor</i>	Maincor Rohrsysteme GmbH & Co. KG Silbersteinstraße 14, D-97424 Schweinfurt
Produktart <i>product category</i>	Installationssysteme und Systemverbinder: Trinkwasserinstallationssystem (8501)
Produktbezeichnung <i>product description</i>	Trinkwasserinstallationssystem bestehend aus Pressverbindern aus Metall und Verbundrohren (PE-RT/Al/PE-RT), 16, 20, 25 und 32 mm, unverpresst undicht
Modell <i>model</i>	MPR Mainpress
Prüfberichte <i>test reports</i>	Kontrollprüfung Labor: 483219/0.1/133920 vom 26.02.2019 (SKZ) Baumusterprüfung: 117326/17-I vom 03.05.2018 (SKZ) Mechanikprüfung: 94577/11-II vom 09.07.2011 (SKZ) Mechanikprüfung: 94577/11-I vom 03.02.2012 (SKZ) Mechanikprüfung: 89073/09-I vom 13.10.2010 (SKZ)
Prüfgrundlagen <i>test basis</i>	DVGW W 534-(P) (01.07.2015) DVGW CERT ZP 8500 (09.03.2017) UBA METALLE (21.11.2018) UBA ELASTOM (16.03.2016) UBA KTW (07.03.2016) DVGW W 270 (01.11.2007)
Ablaufdatum / AZ <i>date of expiry / file no.</i>	16.07.2024 / 19-0454-WNV

0808-04-01

08.08.2019 LE A-1/2

Datum, Bearbeiter, Blatt, Leiter der Zertifizierungsstelle
date, issued by, sheet, head of certification body

DVGW CERT GmbH ist von der DAkkS nach DIN EN ISO/IEC 17065:2013
akkreditierte Stelle für die Zertifizierung von Produkten der Energie- und
Wasserversorgung.

*DVGW CERT GmbH is an accredited body by DAkkS according to DIN EN
ISO/IEC 17065:2013 for certification of products for energy and water supply
industry.*



DVGW CERT GmbH
Zertifizierungsstelle

Josef-Wirmer-Str. 1-3
53123 Bonn

Tel. +49 228 91 88 - 888
Fax +49 228 91 88 - 993

www.dvgw-cert.com
info@dvgw-cert.com



CERT

DVGW-Baumusterprüfzertifikat DVGW type examination certificate

DW-8236BU0016

Registriernummer
registration number

Anwendungsbereich <i>field of application</i>	Produkte der Wasserversorgung <i>products of water supply</i>
Zertifikatinhaber <i>owner of certificate</i>	Maincor Rohrsysteme GmbH & Co. KG Silbersteinstraße 14, D-97424 Schweinfurt
Vertreiber <i>distributor</i>	Maincor Rohrsysteme GmbH & Co. KG Silbersteinstraße 14, D-97424 Schweinfurt
Produktart <i>product category</i>	Verbundrohre für die Trinkwasserinstallation: PE-RT/Al/PE-RT-Rohr, Fert.-Gr. 1 (8236)
Produktbezeichnung <i>product description</i>	Verbundrohr (PE-RT/Al/PE-RT) für die Trinkwasserinstallation
Modell <i>model</i>	Mainpipe
Prüfberichte <i>test reports</i>	Kontrollprüfung Labor: 469018/2.1/131503 vom 18.09.2018 (SKZ) Kontrollprüfung Labor: 469013/1.1/105439 vom 20.06.2013 (SKZ) Kontrollprüfung Labor: 469012/2.1104365 vom 24.06.2013 (SKZ) Baumusterprüfung: 78929/07 vom 28.01.2009 (SKZ) KTW-Prüfung: KR 006/18 vom 27.03.2018 (TZW) Mikrobiologische Prüfung: W-235560-13-SI vom 12.11.2013 (WHY)
Prüfgrundlagen <i>test basis</i>	DVGW W 542 (01.08.2009) UBA KTW (07.03.2016) DVGW W 270 (01.11.2007)
Ablaufdatum / AZ <i>date of expiry / file no.</i>	28.01.2024 / 18-0639-WNV

26.11.2018 Fk A-1/2

Datum, Bearbeiter, Blatt, Leiter der Zertifizierungsstelle
date, issued by, sheet, head of certification body

DVGW CERT GmbH ist von der DAkkS nach DIN EN ISO/IEC 17065:2013
akkreditierte Stelle für die Zertifizierung von Produkten der Energie- und
Wasserversorgung.

DVGW CERT GmbH is an accredited body by DAkkS according to DIN EN
ISO/IEC 17065:2013 for certification of products for energy and water supply
industry.



DVGW CERT GmbH
Zertifizierungsstelle

Josef-Wirmer-Str. 1-3
53123 Bonn

Tel. +49 228 91 88 - 888
Fax +49 228 91 88 - 993

www.dvgw-cert.com
info@dvgw-cert.com

technical approval-with-product certificate K89879/01



Issued 2015-11-15
Replaces -
Page 1 of 3

MPR Mainpress

STATEMENT BY KIWA

With this technical approval-with-product certificate, issued in accordance with the Kiwa Regulations for Product Certification, Kiwa declares that legitimate confidence exists that the products supplied by

MAINCOR Rohrsysteme GmbH & Co. KG

As specified in this technical approval-with-product certificate and marked with the Kiwa®-mark in the manner as indicated in this technical approval-with-product certificate may, on delivery, be relied upon to comply with Kiwa evaluation guideline BRL-K536 G "Plastics piping systems of PE-RT/Al intended for transport of hot and cold drinking water" dated 15-12-2011 inclusive amendment sheet dated 10-03-2015.

Within the framework of this technical approval-with-product certificate Kiwa does not impose any inspections with regard to the production of other parts of the plastics piping system, nor the manufacturing of the plastics piping system itself.

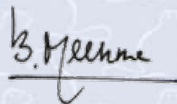

Bouke Meekma
Kiwa

Publication of the certificate is allowed.

Advice: consult www.kiwa.nl in order to ensure that this certificate is still valid.

Kiwa Nederland B.V.
Sir Winston Churchilllaan 273
Postbus 70
2280 AB RIJSWIJK
The Netherlands

Tel. +31 88 998 44 00
Fax +31 88 998 44 20
info@kiwa.nl
www.kiwa.nl



Supplier

MAINCOR Rohrsysteme GmbH & Co. KG
Silbersteinstraße 14
97424 SCHWEINFURT
Duitsland
T +49(0)97 21 / 65977 - 100
F +49(0)97 21 / 65977 - 200
E info@maincor.de
I www.maincor.de

Certification process consists of initial and regular assessment of:

- quality system
- product



Österreichische Vereinigung für das Gas- und Wasserfach
A-1010 Wien, Schuberting 14
Telefon: +43 / 1 / 513 15 88-0* / Telefax: +43 / 1 / 513 15 88-25
E-Mail: office@ovgw.at / Internet: www.ovgw.at

Akkreditiert durch das Bundesministerium
für Digitalisierung und Wirtschaftsstandort



ÖVGW-Zertifikat

Über die Verleihung des Rechtes
zur Führung der ÖVGW-Qualitätsmarke Wasser

Registrierungsnummer

W 1.498

Produkt

MAINPRESS

Geltungsdauer

bis Ende August 2022

Mehrschichtverbund-Rohrleitungssystem

in den Dimensionen Ø 16 – 32 mm

Inhaber

Maincor Rohrsysteme GmbH & Co. KG
Silbersteinstraße 14
97424 Schweinfurt
DEUTSCHLAND

Weitere Angaben siehe Seite 2

◆ Vertrieb in Österreich

Maincor Gebäudetechnik GmbH
Bachwinkl 27
5761 Maria Alm am Steinernen Meer

Hersteller

Maincor Rohrsysteme GmbH & Co KG / DE

Prüfungsart

Verlängerungsprüfung

Prüfbericht

TGM - VA KU 27457/1

Qualitätsstandards/Prüfrichtlinien

• QS-W 301 Ausgabe November 2017

ZVR 818159001

Die Verleihung erfolgt unter Zugrundelegung der Allgemeinen Geschäftsbedingungen GW 30 ÖVGW-Qualitätsmarke Produkte Gas & Wasser „Voraussetzungen für die Zuerkennung der ÖVGW-Qualitätsmarke für Produkte der Gas- und Wasserversorgung.“

Wien, am 12. Dezember 2019

Dipl.-Ing. (FH) Alexander Schwanzer
Leiter der ÖVGW-Zertifizierungsstelle



GERMANY

Hotline: +49 9721 659 77-100

Fax: +49 9721 659 77-200

Homepage: www.maincor.de

E-Mail: info@maincor.de

MAINCOR Rohrsysteme GmbH & Co. KG

Silbersteinstraße 14

97424 Schweinfurt



www.maincor.de



info@maincor.de



facebook.com/MaincorRohrsysteme