



Mainfloor

Underfloor heating systems



THE TECHNICAL MANUAL

Mainfloor

Underfloor heating systems

DRY CONSTRUCTION SYSTEM

DRY CONSTRUCTION SYSTEM - ECO

RENOVATION SYSTEM (MINI)

STAPLER SYSTEM

RAIL SYSTEM

PIPE POSITIONING PANEL SYSTEM

WALL HEATING SYSTEM

All legal and technical information has been carefully compiled to the best of our knowledge. No liability can be accepted for any errors or omissions. This document including the contents is protected by copyright. Any use prohibited by copyright is not allowed without the permission of MAINCOR Rohrsysteme GmbH & Co. KG. All rights reserved. In particular reprinting, editing, storage and processing in electronic systems, translations and microfilms. Subject to printing errors and technical changes. All previous versions lose their validity. Please consider legal provisions, technical regulations, approvals and standards.

1. General	4
1.2 Laying methods	5
1.3 Thermal insulation and impact sound requirements	6
2. Types of pipes	10
2.1 PE-RT	10
2.2 Composite pipe PE-RT / AL / PE-RT	11
2.3 PE-Xa	12
2.4 Classification	13
2.5 Connection system	14
3. Underfloor heating systems	15
3.1 Dry construction system	15
3.2 Dry construction system - Eco	40
3.3 Renovation system (Mini)	42
3.4 Stapler system	46
3.5 Rail system	48
3.6 Pipe positioning panel system	50
3.7 Wall heating system	52
4. Control system	59
4.1 Basic principles	59
4.2 Control technology 4.0	60
4.3 Actuator	62
4.3.1 Actuator 4.0	62
4.3.2 NEO Actuator	66
4.4 Room thermostat 4.0	67
4.5 Room thermostat flush-mounted	70
4.6 Terminal strip 4.0	71
4.7 Regulation-box RTL	73
5. Accessories	74
5.1 Heating manifolds	74
5.2 Flow meters	75
5.3 Hydronic balance with flow limiter	76
5.4 Constant control kit	78
5.5 Distribution cabinets	81
5.6 Screed additive	84
6. Performance tables	85
7. Standards	88
8. Certificates	89
9. Reports	93

1. General

Over the past few years, underfloor heating has become highly popular for heating homes and industrial buildings. What was once considered to be relatively expensive can now be fitted or retrofitted in almost any building at low cost.

The advantages are not only the cosy warmth provided and architectural freedom in interior design, but also the low flow temperature and energy saving aspects.

Lower energy consumption means lower heating costs and a lower CO₂ impact on the environment. This enables optimal use of renewable energies and condensing heating technology. Heat pump systems are extremely energy-efficient and require minimum energy input throughout the year.

HEAT DISTRIBUTION
FOR UNDER FLOOR HEATING AND RADIATORS

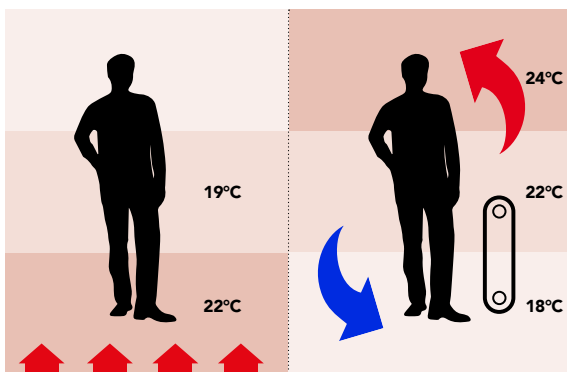

HEATING TECHNOLOGIES AT A GLANCE

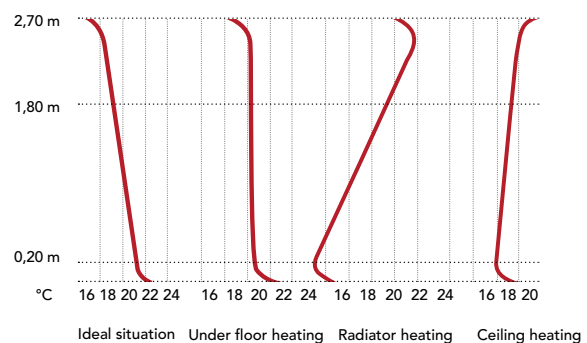

The energy saving provided by underfloor heating results from the heat radiated from surrounding components. In order to provide the same level of comfort as conventional radiator heating, it is possible to reduce the room temperature by 1-2°C. Reducing the room temperature by just 2°C results in an annual cost saving of 12 %.

A further reason for using underfloor heating is the cosy warmth it provides. The exchange of heat between the human body and surrounding surfaces, the temperature of which is evenly distributed and slightly lower than the body, is perceived as particularly pleasant.

Lower temperatures mean higher relative humidity. Underfloor heating is the only type of system to radiate heat upwards draught-free with an almost ideal temperature profile. The low heat radiation also suppresses dust turbulence.

1.2 Laying methods

Bifilar pattern

Features

- mainly used for tight laying distances or awkwardly shaped rooms
- uncomplicated pipe layout due to mostly 90° installation
- uniform heat distribution
- Bending radii must be taken into account

Application

all types of buildings

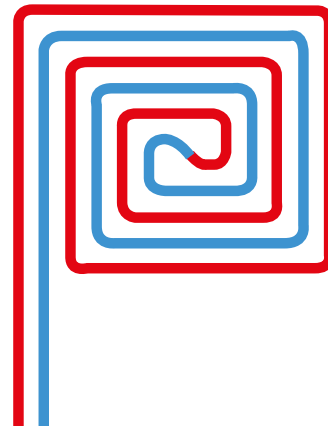

Meander pattern

Features

- fast and easy installation in particular when using the rail system
- heating circuit starting at window or external wall
- slight temperature drops between flow and return
- for laying in large window areas with preceding marginal zone

Application

for all types of buildings, in particular industrial underfloor heating, wall heating, concrete core activation, surface embedded heating

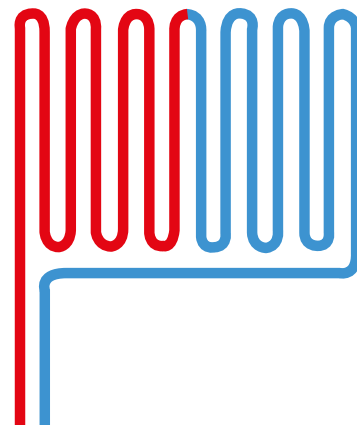

1.3 Thermal insulation and impact sound requirements

What are the insulation requirements in Germany and Europe?

EN 1264 states the minimum thermal resistance value (called U-value) in buildings. Heat insulation requirements for Germany are defined in the Energy Saving Ordinance (EnEV) and can exceed the values specified in EN 1264 in some cases. The specific heat loss of a building can be calculated by an

Standard	Description
EN 1264	Underfloor heating, system components
EnEv	Energy Saving Ordinance
DIN 4108	Thermal insulation in buildings
DIN 4109	Sound insulation in buildings
EN 12831	Calculation of the design heat load
DIN V 18599	Calculation of the net, final and primary energy demand
EN ISO 6946:2008-04 DIN 1996-11	Building components and building elements - Thermal resistance and thermal transmittance - Calculation method
EN ISO 7345 as DIN 1996-01	Thermal insulation - Physical quantities and definitions
EN ISO 9346 as DIN 1996-08	Thermal insulation, mass transfer - Physical quantities and definitions
EN 12524	Building materials and products - Hygrothermal properties

architect or energy adviser taking into account the total thermal envelope. The assessment of the energy efficiency is documented in an energy performance certificate. The U-values of the respective components are documented in the energy pass and are compulsory for contractors.

ENEV 2014 and EN 1264

On 16 October 2013, the Federal Government adopted amendments to the Energy Saving Ordinance (EnEV). The amendments came into force on 1 May 2014 for the most part. The Federal Government is endeavouring to fulfil the commitments agreed in the 1997 Kyoto Protocol with the aim of ensuring that virtually all existing building stock is climate-neutral by 2050. The EU Directive (2010/31/EU), which specifies the total energy efficiency of buildings, is the basis for EnEV 2014. The most important requirement of the Energy Saving Ordinance (EnEV) for new buildings is the annual primary energy demand compared to a standardised reference building with the same dimensions and geometry and specified technical features. Focusing on the total energy demand has the advantage that less efficient insulation can be compensated by a highly efficient heating system and vice versa. According to the reference made in the Energy Saving Ordinance (EnEV) to pertinent DIN, DIN EN and ISO specifications and applicable technical directives, special reference is made here to possible updates and amendments that were not yet in force at the time of printing this technical manual.

As the main bulk of the heat generated by an underfloor heating system must be radiated upwards, the thermal resistance of the layers below are subject to specific requirements. DIN EN 1264, part 4 distinguishes between three types of floor and ceiling constructions with the minimum thermal resistances shown in the table opposite.

Thermal insulation		R_{ins} (m ² /K)
A	Rooms for similar use	0.75 m ² K/W
B	Rooms not for similar use*, unheated rooms (e.g. basements) and ground	1.25 m ² K/W
C	Outside air (-15°C) (e.g. underground car parks, thoroughfares)	2.00 m ² K/W

Example:

Reference object according to German Energy Saving Ordinance (EnEV):

Ceiling against outside air: $U=0.28$ W (m²K)

Insulation roll 30-2 WLG 040 + 110 mm EPS WLG 040

Floor slab against ground and ceiling to unheated rooms $U=0.35$ W (m²K)

Insulation roll / pipe positioning plate 30-2 WLG 040 + 80 mm EPS 040

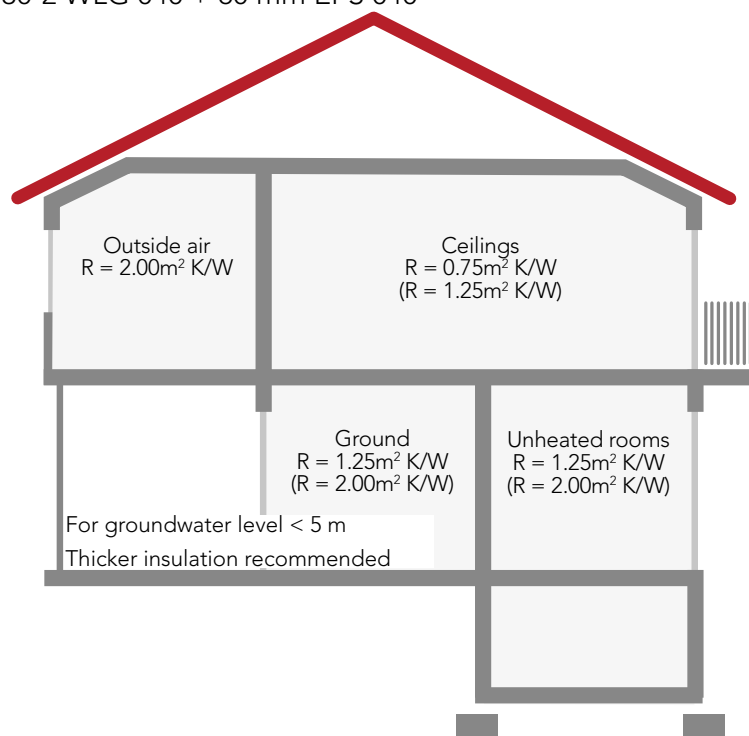

IMPORTANT!

Insulation requirements according to the Energy Saving Ordinance (EnEV) must be taken into account! Thermal insulation specifications for underfloor heating systems according to DIN EN 1264, part 4 and DIN 4701, part 2 (minimum requirements).

Floor	$R_{D\bar{A}}$	Insulation layer thickness in dependence to insulation resistance (mm)					
		[m ² K/W]	045	040	035	030	025
A heated room below	0.75	35	30	30	25	20	
B unheated room or at distances to heated room below or directly at ground level (groundwater > 5 m)*	1.25	60	50	45	40	35	
C outside air**	Design temperature $\geq 0^{\circ}\text{C}$	1.25	60	50	45	40	35
	Design temperature $< 0^{\circ}\text{C} \geq -5^{\circ}\text{C}$	1.5	70	60	55	45	40
	Design temperature $< -5^{\circ}\text{C} \geq -15^{\circ}\text{C}$	2	90	80	70	60	50
*) at a groundwater level of ≤ 5 m, a higher R-value should be used							
**) these values are considerably reduced compared to insulation layers previously used in normal practice							

Impact sound requirements

DIN 4109 defines requirements for the sound insulation of rooms requiring protection against noise. Distinction is made between two types of sound transmission: impact and airborne sound. The minimum requirement for $L'_{n,w}$ is 53db. The impact sound level is made up of the normalised impact sound level of a solid floor without floor covering and the impact sound level reduction of a floor covering. Calculation takes place according to DIN 4109 as shown in the table above. Increased sound insulation as specified in supplement 2 of DIN 4109 is achieved by an additional reduction of about 5db. The impact sound level reduction is related to the equivalent dynamic stiffness according to DIN 29052-1. The table below shows the dependence between the reduction ΔL_w and dynamic stiffness s' :

Dynamic stiffness s' (MN/m ³)	Reduction level L_w (db)		
≤ 30	26	$L'_{n,w} = L_{n,w,eq} - \Delta L_w + 2 \text{ dB}$	
≤ 20	28		
≤ 15	29		
≤ 10	30		
		$L'_{n,w}$	weighted normalised impact sound level of the entire floor construction
		$L_{n,w,eq}$	equivalent weighted normalised impact sound level of solid floor without floor covering
		ΔL_w	Impact sound level reduction of floor covering
		2 dB	Safety margin

The dynamic stiffness according to EN 13163 must also be specified. EN 13163 specifies „Thermal insulation products for buildings - Factory made expanded polystyrene (EPS) products“. Specified are material properties with reference to related test methods and conformity assessment, marking and labelling requirements. Applicationspecific requirements are nationally regulated. In Germany, this takes place via the application standard DIN 4108-10 „Thermal insulation and energy economy in buildings“. This specifies minimum requirements for all european harmonised insulation materials for different areas of application.

Product data	Symbol	Description
Compression resistance	dm	moderate compression resistance
	ds	very high compression resistance
Acoustic properties	sg	low compressibility
	sm	moderately compressible
Insulation	DEO	Interior insulation of ceilings and floor slabs under screed without noise protection requirements
	DES	Interior insulation under screed on ceilings or floors with noise protection requirements

Requirements for substructures

Installation of the MAINFLOOR dry construction system is subject to the following conditions: Substructures must be dry, firm, rigid and free from cracks, dirt and parting compounds must be removed. The dry construction elements must have full contact and rest flat against the substructure as the load distribution layers in dry construction systems are unable to compensate for any unevenness. Any unevenness must be compensated by appropriate measures. This can take place with dry fill material or earth-moist insulation; depending on the particular requirements, other compensating methods that have been approved and tested in compliance with the relevant technical directives can also be used. To prevent damage from rising moisture, the following moisture barriers/foils must be installed, e.g. bituminous or plastic sheeting with appropriate certification. The requirements of DIN 18650-5 must be observed.

Supplementary thermal insulation

For increasing the thermal insulation below the MAINFLOOR dry floor system in rooms at ground level or adjacent to rooms without heating or limited heating subject to compliance with the requirements of the Energy Saving Ordinance (EnEV) and DIN EN 1264.

Products

Expanded polystyrene EPS 035 DEO 200 kPa 1,000 x 500 x 20 mm or 30 mm

Thermal conductivity: 0.035W/m²K

Extruded polystyrene XPS 035 DEO 300 kPa 1,250 x 600 x 30 mm

Thermal conductivity: 0.035W/m²K

Compressive stress: 0.30N/mm² with 10% compression

Building material class: B1 (flame retardant) according to DIN 4102

Extruded polystyrene XPS 035 DEO 500 kPa 1,250 x 600 x 40, 50 or 60 mm

Thermal conductivity: 0.035W/m²K

Compressive stress: 0.50N/mm² with 10% compression

Building material class: B1 (flame retardant) according to DIN 4102

Weight of construction

The dry construction system is light in construction. This is an essential requirement for the refurbishment of old buildings. Structural data must be taken into account.

Layer construction DIN 18560 Design B

No contact with the screed occurs due to the separation of the system components of the construction. Expansion joints therefore do not need to be taken into account as for wet systems.

2. Types of pipes

2.1 PE-RT

Different types of MAINCOR PE-RT pipes are available. All MAINCOR underfloor heating pipes are oxygen tight according to DIN 4726. PE-RT pipe has five layers with an embedded EVOH layer.

Areas of application

Underfloor heating
Radiator connection
Concrete core activation
Open space heating
Special applications

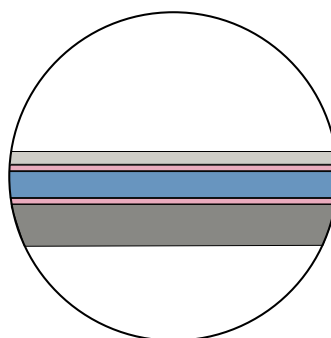

- Outer layer of PE-RT
- Primer
- EVOH layer
- Primer
- Inner pipe of PE-RT

Product data

Description/Dim.	10 x 1.3	14 x 2.0	16 x 1.5	16 x 2.0	17 x 2.0	20 x 2.0
Colour	red	natural	natural	natural	natural	natural
Max. temperature load	90°C	90°C	90°C	90°C	90°C	90°C
Max. continuous temperature load	70°C	70°C	70°C	70°C	70°C	70°C
Max. operating pressure (ISO 10508) at 70°C	6 bar	6 bar	6 bar	6 bar	6 bar	6 bar
Application class (ISO 10508)	Class 4/6	Class 4/6	Class 4/6	Class 4/6	Class 4/6	Class 4/6
Water capacity l/m	0.043 l/m	0.079 l/m	0.133 l/m	0.113 l/m	0.133 l/m	0.201 l/m
Bending radius	5 x d	5 x d	87,5 mm	5 x d	5 x d	5 x d
Surface roughness	40 nm	40 nm	40 nm	40 nm	40 nm	40 nm

2.2 Composite pipe PE-RT / AL / PE-RT

MAINCOR PE-RT / AL / PE-RT multilayer composite pipe with embedded aluminium layer is oxygen tight according to DIN 4726. Despite being highly flexible, this multilayer composite pipe is characterised by high tenacity and fatigue strength.

Areas of application

Underfloor heating
 Radiator connection
 Concrete core activation
 Open space heating
 Special applications

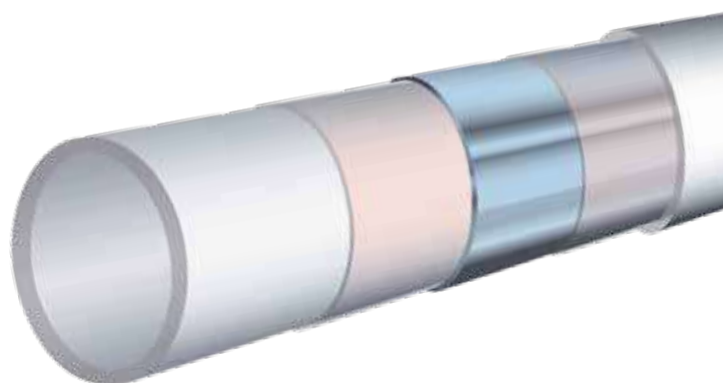

Product data

Description/Dim.	16 x 2.0
Colour	red
Max. temperature load	95°C
Max. continuous temperature load	70°C
Max. operating pressure (ISO 10508) at 70°C	6 bar
Application class (ISO 10508)	Class 4/6
Water capacity	0.113 l/m
Bending radius	5 x d
Surface roughness	40 nm

2.3 PE-Xa

Different types of MAINCOR PE-Xa pipe are available. All MAINCOR underfloor heating pipes are oxygen tight according to DIN 4726. The PE-Xa pipe has five layers with an embedded EVOH layer.

Areas of application

Radiator connection
Underfloor heating
Wall heating
Floor cooling
Ceiling cooling

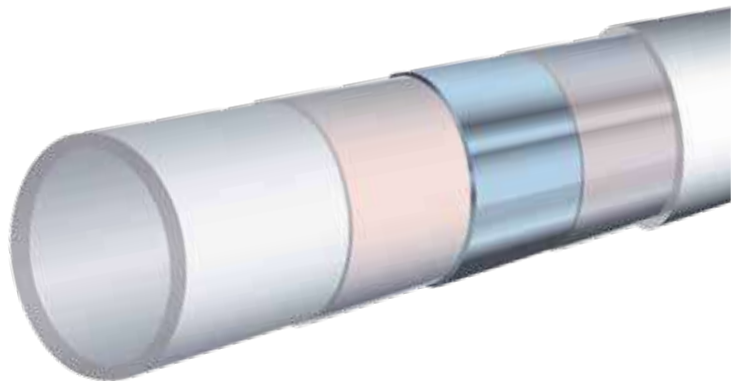

Product data

Description/Dim.	16 x 2.0	17 x 2.0	20 x 2.0
Colour	natural	natural	natural
Max. temperature load	90°C	90°C	90°C
Max. continuous temperature load	70°C	70°C	70°C
Max. operating pressure (ISO 10508) at 70°C	6 bar	6 bar	6 bar
Application class (ISO 10508)	Class 4/6	Class 4/6	Class 4/6
Water capacity	0.113 l/m	0.133 l/m	0.201 l/m
Bending radius	5 x d	5 x d	5 x d
Surface roughness	40 nm	40 nm	40 nm

2.4 Classification

- according to ISO 10508

Pipe performance requirements are specified for five different application classes. The applicable classes are shown in the table below:

Application class	T _D		T _{max}		T _{mal}		Typical area of application
	°C	Years	°C	Years	°C	Hours	
1	60	49	80	1	95	100	Hot water supply (60°C)
2	70	49	80	1	95	100	Hot water supply (70°C)
4	20	2.5	70	2.5	100	100	Underfloor heating and low temperature radiator connections
	40	20					
	60	25					
5	20	14	90	1	100	100	High temperature radiator connections
	60	25					
	80	10					

T = Temperature, T_D = Design temperature, T_{max} = Maximum design temperature, T_{mal} = Fault temperature

Each application class relates to a typical area of application and takes into account a service life of 50 years. Classification corresponds to the requirements in ISO 10508-4. All specified typical fields of application are recommendations and for guidance only. Each application class has a corresponding permissible operating pressure of 4 bar, 6 bar, 8 bar or 10 bar, depending on the particular application.

The concept of the application class defines the purpose of ISO 10508-4 - the theoretical description of dynamic conditions within the application classes accurately reflects the reality compared to structural data. Manufacturers, planners and installers are provided with a basis for the selection of suitable pipes for specific areas of application. The application classes 4 and 5 are valid specifically for heating applications, while classes 1 and 2 are valid for hot water supply. The product standards DIN EN ISO 15875, DIN EN ISO 22391 and DIN EN ISO 21003 define the application classes for geometrical conditions.

Areas of application

Different types of MAINCOR pipes are available for diverse areas of application. The following table shows the possible applications of individual pipes for MAINCOR underfloor heating systems.

Pipe type	Dimension	System					
		1	2	3	4	5	6
PE-RT/AL/PE-RT	16mm x 2.0mm	x	x		x	x	x
PE-Xc	10mm x 1.3mm			x			
PE-RT	10mm x 1.3mm			x			
PE-RT	14mm x 2.0mm				x	x	x
PE-RT	16mm x 2.0mm				x	x	x
PE-RT	17mm x 2.0mm				x	x	x
PE-RT	20mm x 2.0mm				x	x	x
PE-RT	25mm x 2.3mm				x		
PE-Xa	16mm x 2.0mm				x	x	x
PE-Xa	17mm x 2.0mm				x	x	x
PE-Xa	20mm x 2.0mm				x	x	

- 1 Dry construction system
- 2 Dry construction system - Eco
- 3 Renovation system (Mini)
- 4 Stapler system
- 5 Rail system
- 6 Pipe positioning panel system

2.5 Connection system

The connection system is selected depending on the type of pipe used and machines available.

Pressing system

The pipe is cut off at right-angles, calibrated and deburred. The respective fitting is then pressed onto the pipe. Pressing takes place using a pressing jaw mounted on a suitable press. A tight connection is produced within 10 seconds.



Sliding sleeve system

The pipe is cut off at right angles, the sliding sleeve is fitted to the pipe. The pipe is then widened so that the fitting can be mounted. The sliding sleeve is moved with suitable sliding forks mounted on the respective sliding tool.

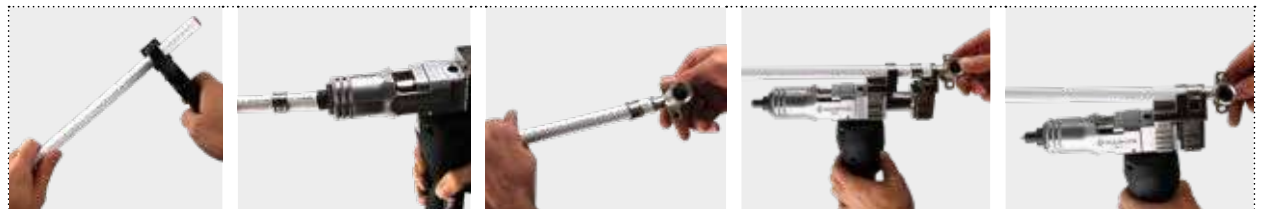

Clamp ring screwing

The clamp ring screwing enables pipe and manifold connections to be established quickly and reliably. The connection between the pipe and fitting is established by a combination of clamp ring screwing and union nut. This is a detachable connection.



3. Underfloor heating systems

3.1 Dry construction system

With its low weight and little height the dry construction system has essential advantages in construction and renovation. This system is right after mounting accessible. Within a short time the setup temperature will be reached.

Areas of application



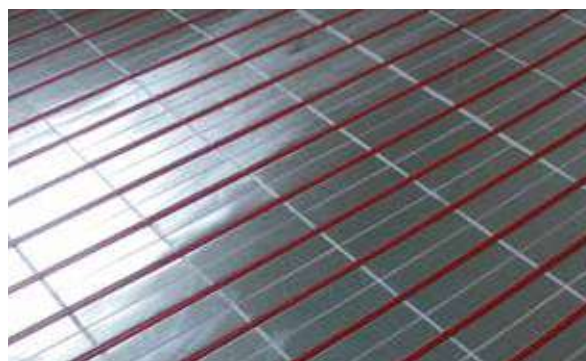





Old and new buildings
 Industrial buildings
 Passive house systems
 Radiant heating and cooling
 Cement and floating screed













System components

Description/Dim.	Dry construction element	Dry construction element
	Alu-VA 12,5	Alu-VA 25
Code	51.903.030	51.903.031
Thickness of plate	30 mm	30 mm
Thickness of insulation	30 mm	30 mm
Compressionability	0	0
Thermal conductivity group	WLG 035	WLG 035
Thermal conductivity in accordance with DIN 4108	0.035 W/mK	0.035 W/mK
Thermal resistance	0.86 m ² K/W	0.86 m ² K/W
Compressive strength	240 kPa	240 kPa
Material	EPS / Alu	EPS / Alu
Applicable norms	EN 13163	EN 13163
Field of application	DEO	DEO
Reaction to fire in accordance with EN 13501	Class E	Class E
Building material class DIN 4102	B1	B1
Installation gap	12.5 cm	25 cm
PU	10 pcs	10 pcs
Size	1.00 m x 0.5 m	1.00 m x 0.5 m

Additional insulation at dry constructions

 ≤ 2.0 kN / m ²	 ≤ 1.0 kN*	Category		 EN 1991	 EN 1991/NA	 SIA 261	
				-	 A2 A3	-	-
Load distribution layer	STRONG-BOARD FL	STRONG-BOARD FL + Laminate	Parquet	Floorboards on sleepers	Fermacell	Fermacell	Estrich-ziegel
Thickness	5 mm	5 + 8 mm	15 mm	20 - 22 mm	20 mm	25 mm	20 mm
EPS DEO 200 kPa WLG 035	max. 20 mm	max. 20 mm	max. 20 mm	max. 40 mm	max. 70 mm	max. 90 mm	max. 130 mm
max. layers	1	1	1	1	2	2	2
XPS DEO 300 kPa WLG 035	max. 30 mm	max. 30 mm	max. 30 mm	max. 50 mm	max. 70 mm	max. 90 mm	max. 140 mm
max. layers	1	1	1	1	2	2	3
XPS DEO 500 kPa WLG 035	max. 60 mm	max. 60 mm	max. 60 mm	max. 80 mm	max. 100 mm	max. 120 mm	max. 190 mm
max. layers	1	1	1	2	2	2	3
Wood fibre insulation 150 kPa	max. 20 mm	max. 20 mm	max. 20 mm	max. 60 mm	max. 40 mm	max. 50 mm	max. 100 mm
max. layers	1	1	1	1	1	1	2
plus 12.5 mm load distribution panel	necessary	necessary	necessary				
Levelling filler	not possible	Additional insulation / filling > 30 mm: reduction of the max. insulation thickness by the filling					
plus 12.5 mm load distribution panel	not possible	thickness → if no additional insulation is used					

 ≤ 2.0 kN / m ²	 ≤ 2.0 kN*	Category		 EN 1991	 EN 1991/NA	 SIA 261	
				 A	-	 A2 A3	 B1 D1
Load distribution layer	STRONG-BOARD FL (Fliese)	STRONG-BOARD FL + Laminate	Parquet	Floorboards on sleepers	Fermacell	Fermacell	Estrich-ziegel
Thickness	5 mm	5 + 8 mm	15 mm	20 - 22 mm	20 mm	25 mm	20 mm
EPS DEO 200 kPa WLG 035	max. 20 mm	max. 20 mm	max. 20 mm	max. 40 mm	max. 50 mm	max. 70 mm	max. 130 mm
max. layers	1	1	1	1	1	2	2
XPS DEO 300 kPa WLG 035	max. 30 mm	max. 30 mm	max. 30 mm	max. 40 mm	max. 50 mm	max. 70 mm	max. 140 mm
max. layers	1	1	1	1	2	2	3
XPS DEO 500 kPa WLG 035	max. 60 mm	max. 60 mm	max. 60 mm	max. 60 mm	max. 70 mm	max. 90 mm	max. 190 mm
max. layers	1	1	1	2	1	2	3
wood fibre insulation 150 kPa	-	max. 20 mm	max. 20 mm	max. 20 mm	-	max. 40 mm	max. 80 mm
max. layers		1	1	1		1	2
plus 12.5 mm load distribution panel		necessary	necessary				
Levelling filler	not possible	Additional insulation / filling > 30 mm: reduction of the max. insulation thickness by the filling					
plus 12.5 mm load distribution panel	not possible	necessary → if no additional insulation is used					

* Individual load (Q_k): laying surface mind. 20 cm², max. deformation < 3 mm; Heavy loads (aquarium, bathtub) have to be considered separately

≤ 2.0 kN / m ²	≤ 1.0 kN*	Category		EN 1991	EN 1991/NA	SIA 261	
				-	A2 A3	-	-
Load distribution layer	STRONG-BOARD FL	STRONG-BOARD FL + Laminate	Parquet	Floorboards on sleepers	Fermacell	Fermacell	Estrich-ziegel
Thickness	5 mm	5 + 8 mm	15 mm	20 - 22 mm	20 mm	25 mm	20 mm
Plus additional OSB installation panel	22 mm	18 mm	18 mm	-	-	-	-
Wood fibre insulation ≥150 kPa: Pavatex Pavaboard 150 kPa Gutex Thermowall-gf 200 kPa Glunz Agepan THD 230 kPa	max. 40 mm	max. 60 mm	max. 60 mm	max. 60 mm	max. 30 mm	max. 70 mm	max. 100 mm
max. layers	1	1	1	1	1	2	2
Levelling filler	not possible	Additional insulation / filling > 30 mm: reduction of the max. insulation thickness by the filling thickness → if no additional insulation is used					
plus 12.5 mm load distribution panel	not possible	Additional insulation / filling > 30 mm: reduction of the max. insulation thickness by the filling thickness → if no additional insulation is used					
For higher insulation thicknesses - use OSB installation panels ≥ 22 mm on sleepers with wood fibre insulation for floor constructions							

≤ 2.0 kN / m ²	≤ 2.0 kN*	Category		EN 1991	EN 1991/NA	SIA 261	
				A	-	A2 A3	B1 D1
Load distribution layer	STRONG-BOARD FL (Fliese)	STRONG-BOARD FL + Laminate	Parquet	Floorboards on sleepers	Fermacell	Fermacell	Estrich-ziegel
Thickness	5 mm	5 + 8 mm	15 mm	20 - 22 mm	20 mm	25 mm	20 mm
Plus additional OSB installation panel	22 mm	18 mm	18 mm	-	-	-	-
Wood fibre insulation ≥150 kPa: Pavatex Pavaboard 150 kPa Gutex Thermowall-gf 200 kPa Glunz Agepan THD 230 kPa	max. 20 mm	max. 40 mm	max. 40 mm	max. 40 mm	-	max. 20 mm	max. 70 mm
max. layers	1	1	1	1	-	1	2
Levelling filler	not possible	Additional insulation / filling > 30 mm: reduction of the max. insulation thickness by the filling thickness → if no additional insulation is used					
plus 12.5 mm load distribution panel	not possible	Additional insulation / filling > 30 mm: reduction of the max. insulation thickness by the filling thickness → if no additional insulation is used					
For higher insulation thicknesses - use OSB installation panels ≥ 22 mm on sleepers with wood fibre insulation for floor constructions							

*Individual load (Q_k): laying surface mind. 20 cm², max. deformation < 3 mm;
Heavy loads (aquarium, bathtub) have to be considered separately

Requirements on the support base

A level, smooth and load bearing surface is required → tolerances of smoothness according to DIN 18202 Tab. 3

1m max. 3mm	Line	Reference	Gauge as limit values in mm with measurement point distances in m				
			0.1 m	1 m	4 m	10 m	15 m
4	Finished floors with increased requirements e. g. with self-levelling compounds		1 mm	3 mm	9 mm	12 mm	15 mm

 Beam ceiling must be torsion-resistant and free of bending

Recommendations for work depending on the height of unevenness

A Unevenness from 3 mm to 30 mm

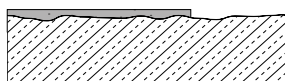

- » Compensate any minor unevenness with smooth plaster:
up to 6 mm smooth plaster (e. g. weber.floor 4010),
up to 30 mm levelling compound (e. g. weber.floor 4160)
- » Primer on shell (e. g. weber.floor 4716)

B Unevenness from 30 mm

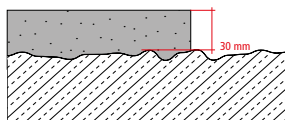

- » Levelling screed (e. g. weber.floor 4341 – alternative for dry construction: fill → **D**)
- » Primer on shell (e. g. weber.floor 4716)
- » Compensate pipe trays up to 50 mm with the bond screed (for higher pipes → **E**)

C Lower and installation height from 30 mm

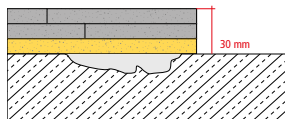

- » Compensation with dry screen bond panel Fermacell 2E31
(20 mm plaster fibre element plus 10 mm wood fibre insulation)
- » Fill any minor, partial unevenness beforehand

D Filling between 10 – 50 mm for smaller properties

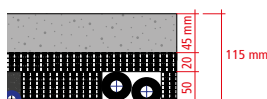

- » Fill any minor, partial unevenness beforehand, e. g. Fermacell bound fillings

E Pipe covers from 30 mm and higher, installation > 110 mm

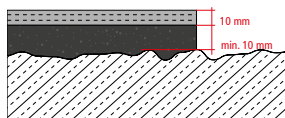

- » Cover with load distribution panel (10 mm plaster fibre)

F Pipe overlap from up to 30 mm and installation height > 110 mm

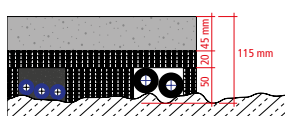

- » With screed on insulation layer

Dry construction system Alu / Strongboard

Floors between rooms with the same temperature

- 1** Tiles / natural stone including adhesive ≥ 12 mm
- 2** STRONGBOARD FL 5 mm
- 3** Adhesive (MAPEI Ecofix)
- 4** Dry construction system + MFL system pipe 30 mm
- 5** Support batten (30 mm)
- 6** Edge insulation strip
- 7** Possible moisture barrier (bond with floor)

≥ 47 mm

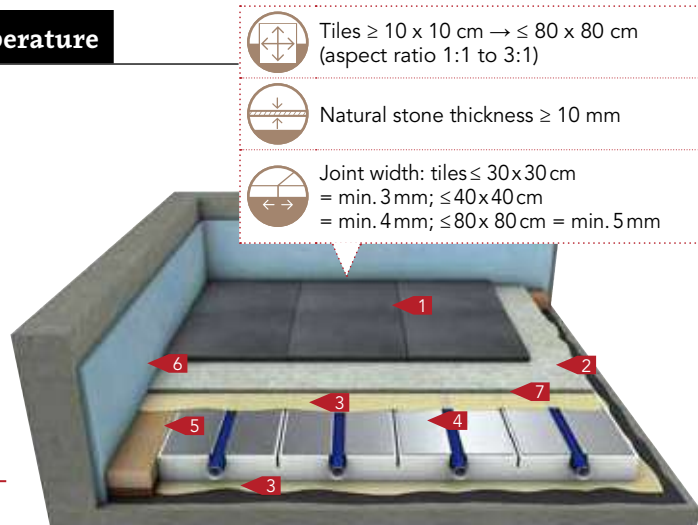

R	0.86 m ² K / W	Minimum heat conductivity resistance fulfilled according to DIN EN 1264	~ 9 kg / m ²	Category	EN 1991	EN 1991/NA	SIA 261
U	0.97 W / m ² K	Thermal transfer resistance R _{si} = 0.17 m ² K/W considered	≤ 2.0 kN / m ²		✓ A	✓ A2 A3	✓ A1
dB	14 dB	Value figure according to DIN ISO 140-8; applies to concrete ceilings > 12 cm (DIN4109:m' > 276 kg/m ²)	≤ 2.0 kN <i>* ≥ 20 cm²</i>		-	✓ B1 D1	-
					-	-	-









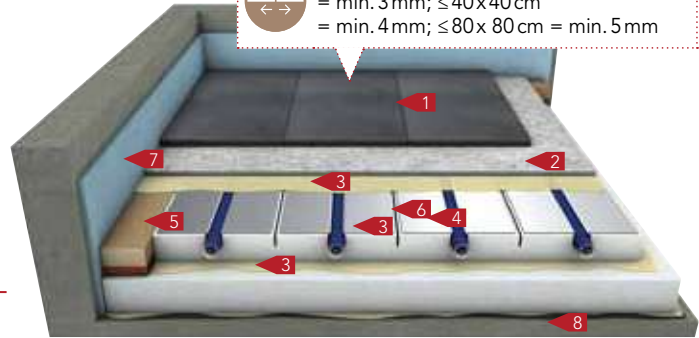



- A level, smooth and load bearing surface is required (increased requirements according to DIN 18202 table 3, line 4)
- Beam ceiling must be torsion-resistant and free of bending L/500 = with a span of e. g. 5 m, the permitted deflection is 1 cm
- Filling (loose and bound) for compensation not permitted
- Fully adhere system elements / material layers to each other and to the substrate
- Lay tiles using the combined method with MAPEI adhesive Elastorapid and join mortar Ultracolor Plus
- This construction applies to apartment partition ceilings with rooms with the same temperature; no additional insulation is required
- Details of the approved individual load (Q_k) relate to a load surface of min. 20 cm² (pressure stamp Ø = 5 cm)









Dry construction system Alu / Strongboard

Floors against unheated rooms / ground

- 1** Tiles / natural stone including adhesive ≥ 12 mm
 - 2** STRONGBOARD FL 5 mm
 - 3** Adhesive (MAPEI Ecofix)
 - 4** Dry construction system + MFL system pipe 30 mm
 - 5** Support batten (30 mm)
 - 6** Additional insulation XPS 035 DEO, 500 kPa (max. 60 mm) 20 mm
 - 7** Edge insulation strip
 - 8** Possible moisture barrier (bond with floor)
- ≥ 67 mm**



	1.43 m ² K / W	Minimum heat conductivity resistance fulfilled according to DIN EN 1264		~ 10 kg / m ²	Category			
	0.70 W / m ² K			≤ 2.0 kN / m ²		EN 1991	EN 1991/NA	SIA 261
	The dry construction system is a thermal insulation without defined footstep sound protection			≤ 2.0 kN * ≥ 20 cm ²		✓ A	✓ A2 A3	✓ A1
						-	✓ B1 D1	-
						-	-	-

-  A level, smooth and load bearing surface is required (increased requirements according to DIN 18202 table 3, line 4)
-  Beam ceiling must be torsion-resistant and free of bending
L/500 = with a span of e. g. 5 m, the permitted deflection is 1 cm
-  Building waterproofing according to DIN 18195 is available under the concrete slab for constructions on the earth, otherwise lay on the floor shell
-  Filling (loose and bound) for compensation not permitted
-  Fully adhere system elements / material layers to each other and to the substrate
-  Lay tiles using the combined method with MAPEI-Kleber Elastorapid and join mortar Ultracolor Plus
-  In case of a payload (q_k) ≤ 2.0 kN/m² and a single load of (Q_k) ≤ 2.0 kN the following insulation thicknesses are permitted:
Additional insulation EPS DEO 200 kPa max. 20 mm (max. one layer)
Additional insulation XPS DEO 300 kPa max. 30 mm (max. one layer)
Additional insulation XPS DEO 500 kPa max. 60 mm (max. one layer)
-  Details of the approved individual load (Q_k) relate to a load surface of min. 20 cm² (pressure stamp Ø = 5 cm) Fill pipe routes with a bound filling up to a max. height of 30 cm. In case of a width over 10 cm, cover with a sheet metal, th. 1 mm. In case of pipe routes with a width of over 15 cm, an additional load distribution layer (min. 18 mm) on the additional insulation is required.

Dry construction system Alu / Strongboard

Floors between rooms with the same temperature

Laminate ≥ 8 mm
without footstep sound insulation

- 1 Laminate ≥ 8 mm
- 2 STRONGBOARD FL 5 mm
- 3 Possible moisture barrier
- 4 Dry construction system + MFL system pipe 30 mm
- 5 Support batten (30 mm)
- 6 Edge insulation strip
- 7 Adhesive

≥ 43 mm

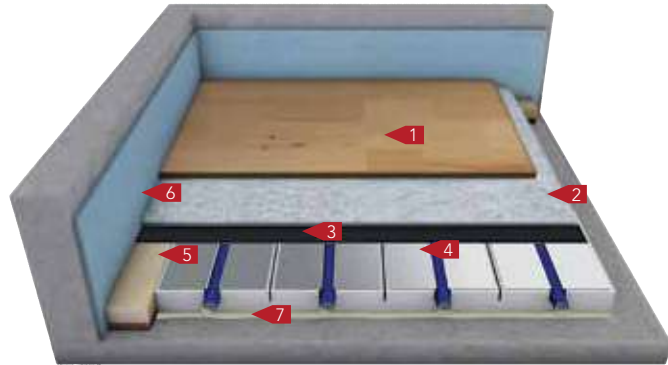

	0.86 m ² K / W	Minimum heat conductivity resistance fulfilled according to DIN EN 1264		~ 15 kg / m ²	Category			
	0.97 W / m ² K	Thermal transfer resistance R _{si} = 0.17 m ² K/W considered		≤ 2.0 kN / m ²		EN 1991	EN 1991/NA	SIA 261
	19 dB	Test figure according to DIN ISO 140-8; applies to concrete ceilings > 12 cm (DIN4109:m' > 276 kg/m ²)		≤ 2.0 kN <small>*≥ 20 cm²</small>		✓ A	✓ A2 A3	✓ A1
						-	✓ B1 D1	-
						-	-	-

- A level, smooth and load bearing surface is required (increased requirements according to DIN 18202 table 3, line 4)
- Beam ceiling must be torsion-resistant and free of bending
L/500 = with a span of e. g. 5 m, the permitted deflection is 1 cm
- Fully adhere system elements / material layers to each other and to the substrate
- This construction applies to apartment partition ceilings with rooms with the same temperature; no additional insulation is required
- Details of the approved individual load (Qk) relate to a load surface of min. 20 cm² (pressure stamp $\varnothing = 5$ cm)
- Protect the upper floor against moisture from below if required according to the manufacturer's details (vapour barrier/block)
- Use of STRONGBOARD FL as a load distribution and footstep sound insulation panel

Dry construction system Alu / Strongboard

Floors against unheated rooms / ground

- | | |
|--|----------------|
| 1 Laminate | ≥ 8 mm |
| 2 STRONGBOARD FL | 5 mm |
| 3 Dry construction system + MFL system pipe | 30 mm |
| 4 Adhesive | |
| 5 Support batten (30 mm) | |
| 6 Additional insulation XPS 035 DEO, 500 kPa | 40 mm |
| 7 Edge insulation strip | |
| 8 Possible moisture barrier (bond with floor) | |
| | ≥ 83 mm |

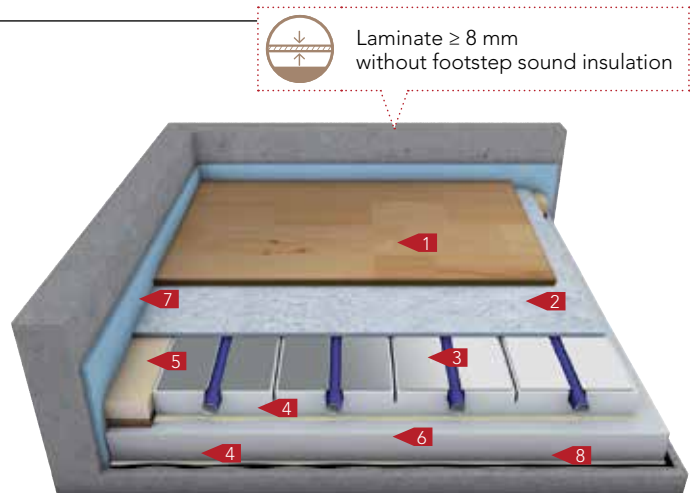

	2.00 m ² K / W	Minimum heat conductivity resistance fulfilled according to DIN EN 1264		~ 16 kg / m ²	Category			
	0.50 W / m ² K			≤ 2.0 kN / m ²		EN 1991	EN 1991/NA	SIA 261
	The dry construction system is a thermal insulation without a defined footstep sound insulation			≤ 2.0 kN *≥ 20 cm ²		✓ A	✓ A2 A3	✓ A1
						-	✓ B1 D1	-
						-	-	-

- A level, smooth and load bearing surface is required (increased requirements according to DIN 18202 table 3, line 4)
- Beam ceiling must be torsion-resistant and free of bending
L/500 = with a span of e. g. 5 m, the permitted deflection is 1 cm
- Building waterproofing according to DIN 18195 is available under the concrete slab for constructions on the earth, otherwise lay on the floor shell
- Fully adhere system elements / material layers to each other and to the substrate
- In case of a payload (q_k) ≤ 2.0 kN/m² and a single load of (Q_k) ≤ 2.0 kN, the following insulation thicknesses are permitted:
 - Additional insulation EPS DEO 200 kPa max. 20 mm (max. one layer)
 - Additional insulation XPS DEO 300 kPa max. 30 mm (max. one layer)
 - Additional insulation XPS DEO 500 kPa max. 60 mm (max. one layer)
- Details of the approved individual load (Q_k) relate to a load surface of min. 20 cm² (pressure stamp Ø = 5 cm)
- Protect the upper floor against moisture from below if required according to the manufacturer's details (vapour barrier/block)
- Fill pipe routes with a bound filling up to a max. height of 30 cm. In case of a width over 10 cm, cover with a sheet metal, th.1 mm. In case of pipe routes with a width of over 15 cm, an additional load distribution layer (min. 18 mm) on the additional insulation is required.

Dry construction system Alu / Directly laid parquet

Floors between rooms with the same temperature

- 1 Parquet ≥ 15 mm
- 2 Footstep sound insulation 2 mm
- 3 Possible moisture barrier
- 4 Dry construction system + MFL system pipe 30 mm
- 5 Support batten (30 mm)
- 6 Edge insulation strip
- 7 Adhesive

≥ 47 mm

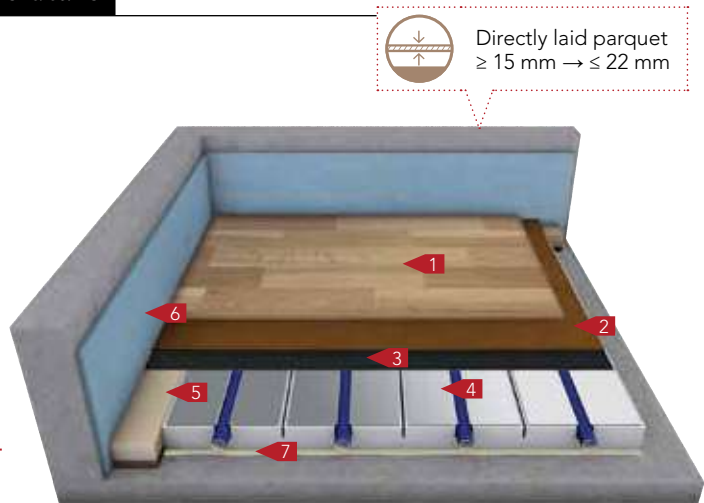

	0.86 m ² K / W	Minimum heat conductivity resistance fulfilled according to DIN EN 1264		~ 13 kg / m ²	Category			
	0.97 W / m ² K	Thermal transfer resistance R _{si} = 0.17 m ² K/W considered		≤ 2.0 kN / m ²		✓ A	✓ A2 A3	✓ A1
	14 dB	Value figure according to DIN ISO 140-8; applies to concrete ceilings > 12 cm (DIN4109:m' > 276 kg/m ²)		≤ 2.0 kN *≥ 20 cm ²		-	✓ B1 D1	-
						-	-	-

- A level, smooth and load bearing surface is required (increased requirements according to DIN 18202 table 3, line 4)
- Fully adhere system elements to the substrate
- This construction applies to apartment partition ceilings with rooms with the same temperature; no additional insulation is required
- Details of the approved individual load (Q_k) relate to a load surface of min. 20 cm² (pressure stamp Ø = 5 cm)
- Protect the upper floor against moisture from below if required according to the manufacturer's details (vapour barrier/block)

Dry construction system Alu / Directly laid parquet

Floors against unheated rooms / ground

- 1 Parquet ≥ 15 mm
- 2 Footstep sound insulation 2 mm
- 3 Dry construction system + MFL system pipe 30 mm
- 4 Support batten (30 mm)
- 5 Additional insulation XPS DEO, 500 kPa 40 mm
- 6 Edge insulation strip
- 7 Possible moisture barrier (bond with floor)
- 8 Adhesive ≥ 87 mm

Directly laid parquet
≥ 15 mm → ≤ 22 mm

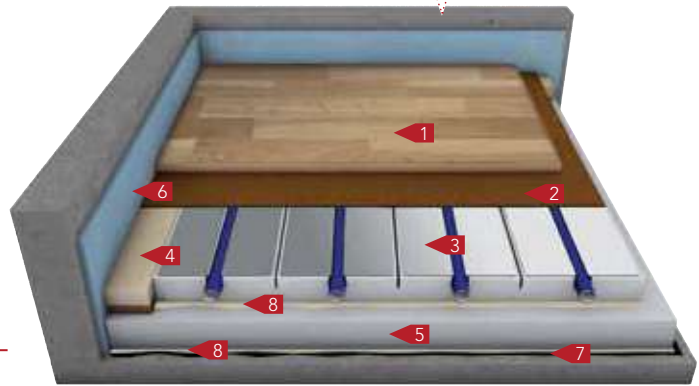

	2.00 m ² K / W	Minimum heat conductivity resistance fulfilled according to DIN EN 1264		~ 14 kg / m ²	Category			
	0.50 W / m ² K			≤ 2.0 kN / m ²		EN 1991	EN 1991/NA	SIA 261
	The dry construction system is a thermal insulation without defined footstep sound protection			≤ 2.0 kN * ≥ 20 cm ²		✓ A	✓ A2 A3	✓ A1
						-	✓ B1 D1	-
						-	-	-

A level, smooth and load bearing surface is required (increased requirements according to DIN 18202 table 3, line 4)

Building waterproofing according to DIN 18195 is available under the concrete slab for constructions on the earth, otherwise lay on the floor shell

Fully adhere system elements / material layers to each other and to the substrate

In case of a payload (q_k) ≤ 2.0 kN/m² and a single load of (Q_k) ≤ 2.0 kN the following insulation thicknesses are permitted:

- Additional insulation EPS DEO 200 kPa max. 20 mm (max. one layer)
- Additional insulation XPS DEO 300 kPa max. 30 mm (max. one layer)
- Additional insulation XPS DEO 500 kPa max. 60 mm (max. one layer)

Details of the approved individual load (Q_k) relate to a load surface of min. 20 cm² (pressure stamp Ø = 5 cm)

- Protect the upper floor against moisture from below if required according to the manufacturer's details (vapour barrier/block)
- Fill pipe routes with a bound filling up to a max. height of 30 cm. In case of a width over 10 cm, cover with a sheet metal, th.1 mm. In case of pipe routes with a width of over 15 cm, an additional load distribution layer (min. 18 mm) on the additional insulation is required.

Dry construction system Alu / Directly laid solid floorboards on sleepers

Floors between rooms with the same temperature

Solid floorboards / ready-to-lay parquet $\geq 15 \text{ mm} \rightarrow \leq 22 \text{ mm}$

- 1** Floorboards $\leq 22 \text{ mm}$
- 2** Dry construction system + MFL system pipe 30 mm
- 3** Planed square timber (30 mm)
- 4** Edge insulation strip
- 5** Possible moisture barrier $\leq 52 \text{ mm}$

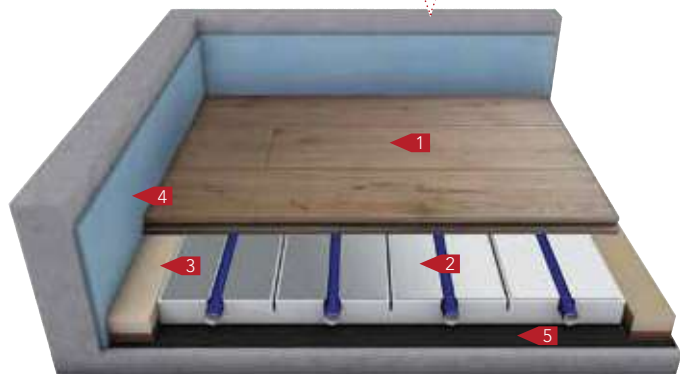

$0.86 \text{ m}^2\text{K} / \text{W}$	Minimum heat conductivity resistance fulfilled according to DIN EN 1264 (square timbers considered pro rata)	$\sim 18 \text{ kg} / \text{m}^2$	Category	EN 1991	EN 1991/NA	SIA 261
$0.97 \text{ W} / \text{m}^2\text{K}$	Thermal transfer resistance $R_{Si} = 0.17 \text{ m}^2\text{K}/\text{W}$ considered	$\leq 2.0 \text{ kN} / \text{m}^2$		✓ A	✓ A2 A3	✓ A1
	The dry construction system is a thermal insulation without defined footstep sound protection	$\leq 2.0 \text{ kN}$ <small>*$\geq 20 \text{ cm}^2$</small>		–	✓ B1 D1	–
				–	–	–

A level, smooth and load bearing surface is required (increased requirements according to DIN 18202 table 3, line 4)

This construction applies to apartment partition ceilings with rooms with the same temperature; no additional insulation is required

Details of the approved individual load (Q_k) relate to a load surface of min. 20 cm^2 (pressure stamp $\varnothing = 5 \text{ cm}$)

Protect the upper floor against moisture from below if required according to the manufacturer's details (vapour barrier/block)

According to the manufacturer of the floorboards, planed square timbers are screwed to the substrate or laid floating

Dry construction system Alu / Directly laid solid floorboards on sleepers

Floors against unheated rooms / ground

- 1 Floorboards ≤ 22 mm
 - 2 Dry construction system + MFL system pipe 30 mm
 - 3 Planed square timber (30 mm)
 - 4 Additional insulation EPS 035 DEO, 200 kPa 40 mm
 - 5 Edge insulation strip
 - 6 Possible moisture barrier
- ≤ 92 mm**

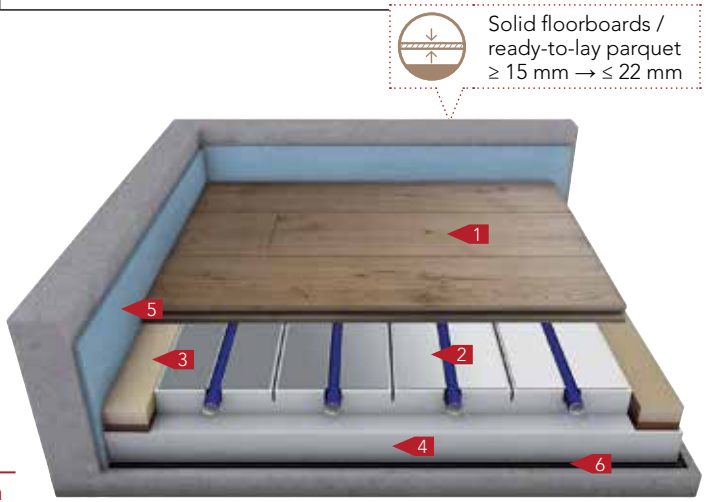

	2.00 m ² K / W	Minimum heat conductivity resistance fulfilled according to DIN EN 1264 (square timbers considered pro rata)
	0.50 W / m ² K	
	The dry construction system is a thermal insulation without defined footstep sound protection	

	~ 20 kg / m ²
	≤ 2.0 kN / m ²
	≤ 2.0 kN * ≥ 20 cm ²

Category	EN 1991	EN 1991/NA	SIA 261
	✓ A	✓ A2 A3	✓ A1
	–	✓ B1 D1	–
	–	–	–

- A level, smooth and load bearing surface is required (increased requirements according to DIN 18202 table 3, line 4)
- Building waterproofing according to DIN 18195 is available under the concrete slab for constructions on the earth, otherwise lay on the floor shell
- Details of the approved individual load (Q_k) relate to a load surface of min. 20 cm² (pressure stamp Ø = 5 cm)
- Protect the upper floor against moisture from below if required according to the manufacturer's details (vapour barrier/block)
- According to the manufacturer of the floorboards, planed square timbers are screwed to the substrate or laid floating

Dry construction system Alu / Fermacell

Floors between rooms with the same temperature

- 1 Carpet/tiles/parquet/laminate/design flooring
- 2 Dry screed element (Fermacell) 20 mm
- 3 Dry construction system + MFL system pipe 30 mm
- 4 Support batten (30 mm)
- 5 Edge insulation strip
- 6 Possible moisture barrier

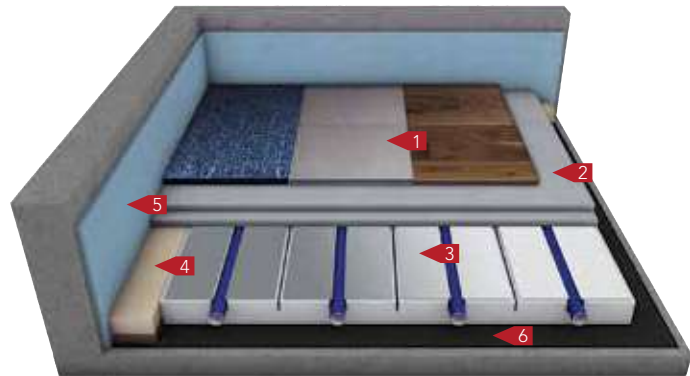

50 mm

0.86 m ² K / W	Minimum heat conductivity resistance fulfilled according to DIN EN 1264	33–53 kg / m ²	Category	EN 1991	EN 1991/NA	SIA 261
0.97 W / m ² K	Thermal transfer resistance R _{Si} = 0.17 m ² K/W considered	≤ 2.0 kN / m ²		✓ A	✓ A2 A3	✓ A1
18 dB	Calculation value according to DIN 4109 on solid ceilings	≤ 2.0 kN *≥ 20 cm ²		–	✓ B1 D1	–
				–	–	–









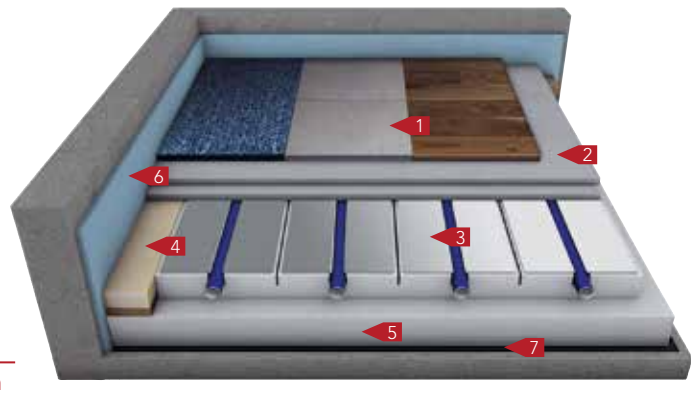















- A level, smooth and load bearing surface is required (increased requirements according to DIN 18202 table 3, line 4)
- This construction applies to apartment partition ceilings with rooms with the same temperature; no additional insulation is required
- Details of the approved individual load (Q_k) relate to a load surface of min. 20 cm² (pressure stamp Ø = 5 cm)
The screed thicknesses can be adjusted for higher load capacities and individual loads

Dry construction system Alu / Fermacell

Floors against unheated rooms / ground

- 1** Carpet/tiles/parquet/laminate/design flooring
- 2** Dry screed element (Fermacell) 20 mm
- 3** Dry construction system + MFL system pipe 30 mm
- 4** Support batten (30 mm)
- 5** Additional insulation EPS 035 DEO, 200 kPa 40 mm
- 6** Edge insulation strip
- 7** Possible moisture barrier



 R	2.00 m ² K / W	Minimum heat conductivity resistance fulfilled according to DIN EN 1264		35–55 kg / m ²	<table border="1"> <thead> <tr> <th>Category</th> <th> EN 1991</th> <th> EN 1991/NA</th> <th> SIA 261</th> </tr> </thead> <tbody> <tr> <td></td> <td>✓ A</td> <td>✓ A2 A3</td> <td>✓ A1</td> </tr> <tr> <td></td> <td>–</td> <td>✓ B1 D1</td> <td>–</td> </tr> <tr> <td></td> <td>–</td> <td>–</td> <td>–</td> </tr> </tbody> </table>	Category	 EN 1991	 EN 1991/NA	 SIA 261		✓ A	✓ A2 A3	✓ A1		–	✓ B1 D1	–		–	–	–
Category	 EN 1991	 EN 1991/NA	 SIA 261																		
	✓ A	✓ A2 A3	✓ A1																		
	–	✓ B1 D1	–																		
	–	–	–																		
 U	0.50 W / m ² K			≤ 2.0 kN / m ²																	
 18 dB		Calculation value according to DIN 4109 on solid floorboards	 Q_k	≤ 1.5 kN * ≥ 20 cm ²																	

 A level, smooth and load bearing surface is required (increased requirements according to DIN 18202 table 3, line 4)

 Building waterproofing according to DIN 18195 is available under the concrete slab for constructions on the earth, otherwise lay on the floor shell

In case of a payload (q_k) ≤ 2.0 kN/m² and a single load of (Q_k) ≤ 2.0 kN the following insulation thicknesses are permitted:

-  Additional insulation EPS DEO 200 kPa max. 50 mm (max. one layer)
- Additional insulation XPS DEO 300 kPa max. 50 mm (max. two layers)
- Additional insulation XPS DEO 500 kPa max. 70 mm (max. one layer)

 Details of the approved individual load (Q_k) relate to a load surface of min. 20 cm² (pressure stamp Ø = 5 cm)
The screed thicknesses can be adjusted for higher load capacities and individual loads

Dry construction system Alu / CREAPUR

Floors between rooms with the same temperature

- 1** Carpet/tiles/parquet/laminate/design flooring
- 2** ESTRICHZIEGEL® CREAPUR 20 mm
- 3** Separating layer
- 4** Dry construction system + MFL system pipe 30 mm
- 5** Support batten (30 mm)
- 6** Edge insulation strip
- 7** Possible moisture barrier

50 mm



$0.86 \text{ m}^2\text{K} / \text{W}$	Minimum heat conductivity resistance fulfilled according to DIN EN 1264	$\sim 41 \text{ kg} / \text{m}^2$	Category	EN 1991	EN 1991/NA	SIA 261
$0.97 \text{ W} / \text{m}^2\text{K}$	Thermal transfer resistance $R_{Si} = 0.17 \text{ m}^2\text{K}/\text{W}$ considered	$\leq 5.0 \text{ kN} / \text{m}^2$		✓ A	✓ A2 A3	✓ A1
	The dry construction system is a thermal insulation without defined footstep sound protection	$\leq 4.0 \text{ kN}$ <small>*$\geq 20 \text{ cm}^2$</small>		✓ B	✓ B1 D1	✓ B
				✓ C1 C3 C5 D1	✓ B2 B3 C1 C3 D2 E1	✓ C D

A level, smooth and load bearing surface is required (increased requirements according to DIN 18202 table 3, line 4)

This construction applies to apartment partition ceilings with rooms with the same temperature; no additional insulation is required

Details of the approved individual load (Q_k) relate to a load surface of min. 20 cm^2 (pressure stamp $\varnothing = 5 \text{ cm}$)
The Creaton screen pavement tile does not belong to the EN or DIN norm; the properties are defined by the CREATON product description

Dry construction system Alu / CREAPUR

Floors against unheated rooms / ground

- 1 Carpet/tiles/parquet/laminate/design flooring
- 2 ESTRICHZIEGEL® CREAPUR 20 mm
- 3 Separating layer
- 4 Dry construction system + MFL system pipe 30 mm
- 5 Support batten (30 mm)
- 6 Additional insulation EPS 035 DEO, 200 kPa 40 mm
- 7 Edge insulation strip
- 8 Possible moisture barrier

≥ 87 mm

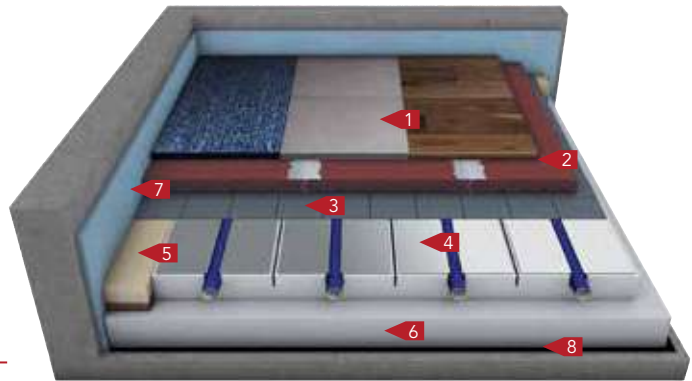

	2.00 m ² K / W	Minimum heat conductivity resistance fulfilled according to DIN EN 1264 (from 20 mm additional insulation)		48–68 kg / m ²	Category			
	0.50 W / m ² K			≤ 5.0 kN / m ²		EN 1991	EN 1991/NA	SIA 261
	The dry construction system is a thermal insulation without defined footstep sound protection			≤ 4.0 kN *≥ 20 cm ²		✓ A	✓ A2 A3	✓ A1
						✓ B	✓ B1 D1	✓ B
						✓ C1 C3 C5 D1	✓ B2 B3 C1 C3 D2 E1	✓ C D

A level, smooth and load bearing surface is required (increased requirements according to DIN 18202 table 3, line 4)

Building waterproofing according to DIN 18195 is available under the concrete slab for constructions on the earth, otherwise lay on the floor shell

In case of a payload (q_k) 2.0 kN/m² and a single load of (Q_k) 2.0 kN the following insulation thicknesses are permitted:

- Additional insulation EPS DEO 200 kPa max. 130 mm (max. two layers)
- Additional insulation XPS DEO 300 kPa max. 140 mm (max. three layers)
- Additional insulation XPS DEO 500 kPa max. 190 mm (max. three layers)

Details of the approved individual load (Q_k) relate to a load surface of min. 20 cm² (pressure stamp Ø = 5 cm)

The Creaton screen pavement tile does not belong to the EN or DIN norm; the properties are defined by the CREATON product description

Dry construction system Alu / CREAPUR

Floors between rooms with the same temperature

- 1** Carpet/tiles/parquet/laminate/design flooring
- 2** ESTRICHZIEGEL® CREAPUR 20 mm
- 3** Separating layer
- 4** Dry construction system + MFL system pipe 30 mm
- 5** Support batten (30 mm)
- 6** Wood fibre footstep sound insulation 21/20 20 mm
- 7** Edge insulation strip
- 8** Possible moisture barrier

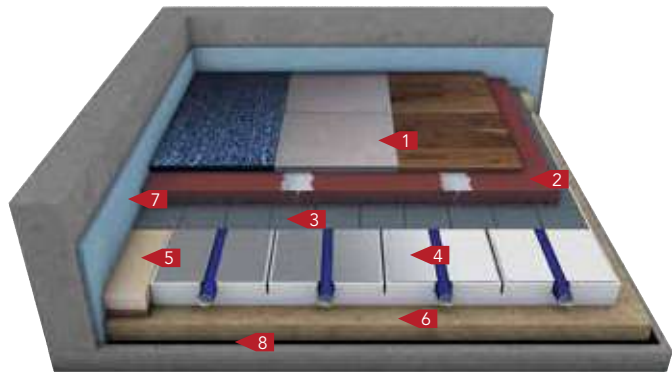

70 mm

	1.3 m ² K / W	Minimum heat conductivity resistance fulfilled according to DIN EN 1264		50–70 kg / m ²	Category			
	0.77 W / m ² K	Thermal transfer resistance R _{si} = 0.17 m ² K/W considered		≤ 2.0 kN / m ²		EN 1991	EN 1991/NA	SIA 261
	27 dB	Calculation value according to DIN 4109 on solid ceilings		≤ 2.0 kN *≥ 20 cm ²		✓ A	✓ A2 A3	✓ A1
						–	✓ B1 D1	–
						–	–	–

- A level, smooth and load bearing surface is required (increased requirements according to DIN 18202 table 3, line 4)
- 21/20 mm wood fibre footstep sound insulation DES sg (low compression)
- Details of the approved individual load (Q_k) relate to a load surface of min. 20 cm² (pressure stamp Ø = 5 cm)
The Creaton screen pavement tile does not belong to the EN or DIN norm; the properties are defined by the CREATON product description

Dry construction system Alu / CREAPUR

Floors between rooms with the same temperature

- 1 ESTRICHZIEGEL® CREAPUR (laid visibly) 20 mm
- 2 Separating layer
- 3 Dry construction system + MFL system pipe 30 mm
- 4 Support batten (30 mm)
- 5 Edge insulation strip
- 6 Possible moisture barrier

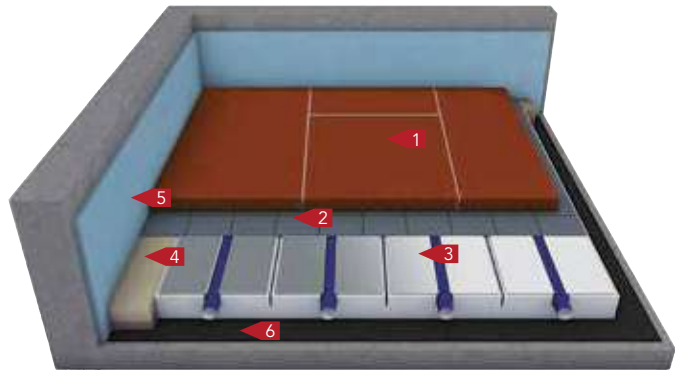

50 mm

	0.86 m ² K / W	Minimum heat conductivity resistance fulfilled according to DIN EN 1264		~ 41 kg / m ²	Category			
	0.97 W / m ² K	Thermal transfer resistance R _{si} = 0.17 m ² K/W considered		≤ 5.0 kN / m ²		✓ A	✓ A2 A3	✓ A1
	The dry construction system is a thermal insulation without defined footstep sound protection			≤ 4.0 kN * ≥ 20 cm ²		✓ B	✓ B1 D1	✓ B
						✓ C1-C3 C5 D1	✓ B2 B3 C1 C3 D2 E1	✓ C D

- A level, smooth and load bearing surface is required (increased requirements according to DIN 18202 table 3, line 4)
- This construction applies to apartment partition ceilings with rooms with the same temperature; no additional insulation is required
- Details of the approved individual load (Q_k) relate to a load surface of min. 20 cm² (pressure stamp Ø = 5 cm)
The Creaton screen pavement tile does not belong to the EN or DIN norm; the properties are defined by the CREATON product description

Thermal output

Dry construction system Alu / Eco

Strongboard FL / Tiles / Laminate

Nominal layer thickness 5 mm
 Thermal conductivity λ 0.2 W / mK
 Spread σ 5 K

Average heating water temperature	Room temperature	Flooring $R_{\lambda,B} = 0.00 \text{ m}^2 \text{ K} / \text{W}$ Tiles				Flooring $R_{\lambda,B} = 0.015 \text{ m}^2 \text{ K} / \text{W}$ Tiles				Flooring $R_{\lambda,B} = 0.05 \text{ m}^2 \text{ K} / \text{W}$ Laminate			
		VA = 125 mm	Surface temperature	VA = 250 mm	Surface temperature	VA = 125 mm	Surface temperature	VA = 250 mm	Surface temperature	VA = 125 mm	Surface temperature	VA = 250 mm	Surface temperature
		θ_m	θ_r	RZ	θ_F	AZ	θ_F	RZ	θ_F	AZ	θ_F	RZ	θ_F
°C	°C	W / m ²	°C	W / m ²	°C	W / m ²	°C	W / m ²	°C	W / m ²	°C	W / m ²	°C
30	15	100.6	24.0	75.6	22.0	89.9	23.2	69.1	21.4	63.5	21.0	49.9	19.8
30	18	80.1	25.3	60.2	23.7	71.5	24.6	55.0	23.2	50.5	22.8	39.7	21.9
30	20	66.3	26.2	49.8	24.8	59.2	25.6	45.5	24.4	41.8	24.1	32.9	23.3
30	22	52.3	27.0	39.4	25.9	46.8	26.5	36.0	25.6	33.0	25.3	26.0	24.6
30	24	38.1	27.7	28.7	26.9	34.1	27.4	26.2	26.7	24.1	26.5	18.9	26.0
35	15	134.7	15.0	101.3	24.1	120.4	25.6	92.6	23.4	85.0	22.8	66.8	21.2
35	18	114.3	28.2	85.9	25.8	102.1	27.2	78.5	25.2	72.1	24.7	56.7	23.4
35	20	100.6	29.0	75.6	27.0	89.9	28.2	69.1	26.4	63.5	26.0	49.9	24.8
35	22	86.9	29.9	65.3	28.1	77.7	29.2	59.7	27.6	54.8	27.2	43.1	26.2
35	24	73.2	30.8	55.0	29.2	65.4	30.1	50.3	28.8	46.1	28.5	36.3	27.6
40	15	168.7	29.5	126.8	26.2	150.7	28.1	115.9	25.3	106.4	24.5	83.7	22.7
40	18	148.3	30.9	111.5	27.9	132.5	29.6	101.9	27.2	93.5	26.5	73.6	24.8
40	20	134.7	31.8	101.3	29.1	120.4	30.6	92.6	28.4	85.0	27.8	66.8	26.2
40	22	121.1	32.7	91.0	30.3	108.2	31.7	83.2	29.6	76.4	29.0	60.1	27.7
40	24	107.4	33.6	80.8	31.4	96.0	32.7	73.8	30.8	67.8	30.3	53.3	29.1
45	15	202.6	32.1	152.3	28.2	181.1	30.4	139.3	27.2	127.8	26.2	100.6	24.0
45	18	182.3	33.5	137.0	30.0	162.9	32.0	125.3	29.0	115.0	28.2	90.5	26.2
45	20	168.7	34.5	126.8	31.2	150.7	33.1	115.9	30.3	106.4	29.5	83.7	27.7
45	22	155.1	35.4	116.6	32.3	138.6	34.1	106.6	31.5	97.8	30.8	77.0	29.1
45	24	141.5	36.3	106.4	33.5	126.4	35.1	97.2	32.8	89.2	32.1	70.2	30.5
50	15	236.5	34.7	177.8	30.2	211.4	32.8	162.6	29.0	149.2	27.9	117.4	25.4
50	18	216.2	36.1	162.5	32.0	193.2	34.4	148.6	30.9	136.4	29.9	107.3	27.6
50	20	202.6	37.1	152.3	33.2	181.1	35.4	139.3	32.2	127.8	31.2	100.6	29.0
50	22	189.1	38.1	142.1	34.4	168.9	36.5	129.9	33.4	119.2	32.6	93.8	30.5
50	24	175.5	39.0	131.9	35.6	156.8	37.5	120.6	34.7	110.7	33.9	87.1	31.9
55	15	270.4	37.2	203.3	32.2	241.7	35.1	185.9	30.8	170.6	29.6	134.2	26.8
55	18	250.1	38.7	188.0	34.0	223.5	36.7	171.9	32.7	157.7	31.6	124.1	29.0
55	20	236.5	39.7	177.8	35.2	211.4	37.8	162.6	34.0	149.2	32.9	117.4	30.4
55	22	223.0	40.7	167.6	36.4	199.3	38.8	153.3	35.3	140.6	34.3	110.7	31.9
55	24	209.4	41.6	157.4	37.6	187.1	39.9	143.9	36.5	132.1	35.6	103.9	33.3



Thermal output on the basis of DIN EN 1264



Maximum surface temperatures according to DIN EN 1264
 Central zone (AZ): 29 °C | Bathrooms: 33 °C | Edge zone (RZ, max. width 100 cm): 35 °C

Thermal output

Dry construction system Alu / Eco

Directly laid parquet

Nominal layer thickness 15 – 20 mm
 Thermal conductivity λ 0.13 W / mK
 Spread σ 5 K

Flooring $R_{\lambda,B} = 0.13 \text{ m}^2 \text{ K} / \text{W}$
 Parquet 15 mm + 2 mm cork

Flooring $R_{\lambda,B} = 0.22 \text{ m}^2 \text{ K} / \text{W}$
 Parquet 20 mm
 ($R_{\lambda,B} > R_{\lambda,Bmax}$ nach DIN EN 1264)

Flooring $R_{\lambda,B} = 0.15 \text{ m}^2 \text{ K} / \text{W}$
 Solid floorboards 20 mm*

Average heating water temperature	Room temperature	Flooring $R_{\lambda,B} = 0.13 \text{ m}^2 \text{ K} / \text{W}$ Parquet 15 mm + 2 mm cork				Flooring $R_{\lambda,B} = 0.22 \text{ m}^2 \text{ K} / \text{W}$ Parquet 20 mm ($R_{\lambda,B} > R_{\lambda,Bmax}$ nach DIN EN 1264)				Flooring $R_{\lambda,B} = 0.15 \text{ m}^2 \text{ K} / \text{W}$ Solid floorboards 20 mm*			
		VA = 125 mm	Surface temperature	VA = 250 mm	Surface temperature	VA = 125 mm	Surface temperature	VA = 250 mm	Surface temperature	VA = 125 mm	Surface temperature	VA = 250 mm	Surface temperature
θ_m	θ_i	RZ	θ_F	AZ	θ_F	RZ	θ_F	AZ	θ_F	RZ	θ_F	AZ	θ_F
°C	°C	W / m ²	°C	W / m ²	°C	W / m ²	°C	W / m ²	°C	W / m ²	°C	W / m ²	°C
30	15	50.5	16.6	40.3	18.9	42.2	19.1	34.5	18.4	45.5	19.4	36.2	18.6
30	18	40.2	19.9	32.0	21.2	33.6	21.3	27.4	20.8	36.2	21.6	28.8	20.9
30	20	33.3	22.1	26.5	22.7	27.8	22.8	22.7	22.3	30.0	23.0	23.9	22.4
30	22	26.3	24.3	21.0	24.2	22.0	24.3	17.9	23.9	23.7	24.4	18.9	24.0
30	24	19.2	26.5	15.3	25.6	16.0	25.7	13.1	25.4	17.2	25.8	13.7	25.5
35	15	67.6	16.6	53.9	20.1	56.5	20.4	46.2	19.5	60.9	20.7	48.5	19.7
35	18	57.4	19.9	45.7	22.4	47.9	22.6	39.2	21.8	51.6	22.9	41.2	22.0
35	20	50.5	22.1	40.3	23.9	42.2	24.1	34.5	23.4	45.5	24.4	36.2	23.6
35	22	43.6	24.3	34.8	25.4	36.5	25.6	29.8	25.0	39.3	25.8	31.3	25.1
35	24	36.7	26.5	29.3	26.9	30.7	27.1	25.1	26.6	33.1	27.3	26.4	26.7
40	15	84.7	16.6	67.5	21.3	70.8	21.6	57.8	20.5	76.2	22.0	60.8	20.7
40	18	74.5	19.9	59.4	23.6	62.2	23.8	50.8	22.9	67.0	24.3	53.4	23.1
40	20	67.6	22.1	53.9	25.1	56.5	25.4	46.2	24.5	60.9	25.7	48.5	24.7
40	22	60.8	24.3	48.5	26.7	50.8	26.9	41.5	26.0	54.7	27.2	43.6	26.2
40	24	54.0	26.5	43.0	28.2	45.1	28.4	36.8	27.6	48.6	28.7	38.7	27.8
45	15	101.8	16.6	81.1	22.4	85.0	22.8	69.4	21.5	91.6	23.3	73.0	21.8
45	18	91.5	19.9	73.0	24.8	76.5	25.0	62.5	23.9	82.4	25.5	65.7	24.1
45	20	84.7	22.1	67.5	26.3	70.8	26.6	57.8	25.5	76.2	27.0	60.8	25.7
45	22	77.9	24.3	62.1	27.8	65.1	28.1	53.1	27.1	70.1	28.5	55.9	27.3
45	24	71.1	26.5	56.6	29.4	59.4	29.6	48.5	28.7	64.0	30.0	51.0	28.9
50	15	118.8	16.6	94.7	23.6	99.2	23.9	81.1	22.4	106.9	24.6	85.2	22.8
50	18	108.6	19.9	86.5	25.9	90.7	26.2	74.1	24.9	97.7	26.8	77.9	25.2
50	20	101.8	22.1	81.1	27.4	85.0	27.8	69.4	26.5	91.6	28.3	73.0	26.8
50	22	94.9	24.3	75.7	29.0	79.3	29.3	64.8	28.1	85.5	29.8	68.1	28.3
50	24	88.1	26.5	70.2	30.5	73.6	30.8	60.1	29.7	79.3	31.3	63.2	29.9
55	15	135.8	16.6	108.3	24.7	113.5	25.1	92.7	23.4	122.2	25.8	97.4	23.8
55	18	125.6	19.9	100.1	27.0	104.9	27.4	85.7	25.8	113.0	28.1	90.1	26.2
55	20	118.8	22.1	94.7	28.6	99.2	28.9	81.1	27.4	106.9	29.6	85.2	27.8
55	22	112.0	24.3	89.3	30.1	93.5	30.5	76.4	29.0	100.8	31.1	80.3	29.4
55	24	105.2	26.5	83.8	31.7	87.8	32.0	71.8	30.7	94.7	32.6	75.4	31.0



Thermal output on the basis of DIN EN 1264

* In the performance tables shown, the area fraction of the counter battens is already taken into account with 10%



Maximum surface temperatures according to DIN EN 1264

Central zone (AZ): 29 °C | Bathrooms: 33 °C | Edge zone (RZ, max. width 100 cm): 35 °C

Thermal output

Dry construction system Alu / Eco

Dry screed element (Fermacell 20 mm)

Nominal layer thickness 20 mm
 Thermal conductivity λ 0.28 W / mK
 Spread σ 5 K

Flooring $R_{\lambda,B} = 0.00 \text{ m}^2 \text{ K} / \text{W}$ Tiles
 Flooring $R_{\lambda,B} = 0.05 \text{ m}^2 \text{ K} / \text{W}$ Parquet, Laminate, Synthetic fibre
 Flooring $R_{\lambda,B} = 0.10 \text{ m}^2 \text{ K} / \text{W}$ Carpet
 Flooring $R_{\lambda,B} = 0.15 \text{ m}^2 \text{ K} / \text{W}$ Velour, Ready-to-lay parquet, Floorboards

Average heating water temperature	Room temperature	Tiles				Parquet, Laminate, Synthetic fibre				Carpet				Velour, Ready-to-lay parquet, Floorboards			
		VA = 125 mm	Surface temperature	VA = 250 mm	Surface temperature	VA = 125 mm	Surface temperature	VA = 250 mm	Surface temperature	VA = 125 mm	Surface temperature	VA = 250 mm	Surface temperature	VA = 125 mm	Surface temperature	VA = 250 mm	Surface temperature
θ_m	θ_i	RZ	θ_F	AZ	θ_F	RZ	θ_F	AZ	θ_F	RZ	θ_F	AZ	θ_F	RZ	θ_F	AZ	θ_F
°C	°C	W / m ²	°C	W / m ²	°C	W / m ²	°C	W / m ²	°C	W / m ²	°C	W / m ²	°C	W / m ²	°C	W / m ²	°C
30	15	74.6	21.9	57.7	20.5	57.7	20.5	46.5	19.5	47.0	19.5	38.9	18.8	39.7	18.9	33.4	18.3
30	18	59.4	23.6	45.9	22.4	45.9	22.4	37.0	21.6	37.4	21.7	31.0	21.1	31.6	21.2	26.6	20.7
30	20	49.1	24.7	38.0	23.7	38.0	23.7	30.6	23.1	30.9	23.1	25.6	22.6	26.1	22.7	22.0	22.3
30	22	38.8	25.8	30.0	25.0	30.0	25.0	24.2	24.5	24.4	24.5	20.3	24.1	20.6	24.1	17.4	23.8
30	24	28.3	26.9	21.9	26.3	21.9	26.3	17.6	25.9	17.8	25.9	14.8	25.6	15.0	25.6	12.7	25.4
35	15	99.9	24.0	77.2	22.1	77.2	22.1	62.3	20.8	62.9	20.9	52.1	20.0	53.1	20.1	44.8	19.3
35	18	84.7	25.7	65.5	24.1	65.5	24.1	52.8	23.0	53.3	23.1	44.2	22.3	45.1	22.4	38.0	21.7
35	20	74.6	26.9	57.7	25.5	57.7	25.5	46.5	24.5	47.0	24.5	38.9	23.8	39.7	23.9	33.4	23.3
35	22	64.4	28.0	49.8	26.8	49.8	26.8	40.2	25.9	40.6	26.0	33.6	25.3	34.3	25.4	28.9	24.9
35	24	54.3	29.2	41.9	28.1	41.9	28.1	33.8	27.4	34.2	27.4	28.3	26.9	28.9	26.9	24.3	26.5
40	15	125.1	26.0	96.7	23.7	96.7	23.7	78.0	22.2	78.7	22.2	65.3	21.1	66.5	21.2	56.1	20.3
40	18	110.0	27.8	85.0	25.8	85.0	25.8	68.6	24.4	69.2	24.4	57.4	23.4	58.5	23.5	49.3	22.7
40	20	99.9	29.0	77.2	27.1	77.2	27.1	62.3	25.8	62.9	25.9	52.1	25.0	53.1	25.1	44.8	24.3
40	22	89.8	30.2	69.4	28.5	69.4	28.5	56.0	27.3	56.5	27.4	46.9	26.5	47.7	26.6	40.2	25.9
40	24	79.7	31.3	61.6	29.8	61.6	29.8	49.7	28.8	50.1	28.8	41.6	28.1	42.4	28.1	35.7	27.5
45	15	150.3	28.0	116.1	25.3	116.1	25.3	93.7	23.5	94.6	23.6	78.4	22.2	79.9	22.3	67.3	21.3
45	18	135.2	29.8	104.5	27.4	104.5	27.4	84.3	25.7	85.1	25.8	70.5	24.6	71.9	24.7	60.6	23.7
45	20	125.1	31.0	96.7	28.7	96.7	28.7	78.0	27.2	78.7	27.2	65.3	26.1	66.5	26.2	56.1	25.3
45	22	115.0	32.2	88.9	30.1	88.9	30.1	71.7	28.6	72.4	28.7	60.0	27.7	61.2	27.8	51.5	26.9
45	24	104.9	33.4	81.1	31.4	81.1	31.4	65.4	30.1	66.0	30.2	54.8	29.2	55.8	29.3	47.0	28.5
50	15	175.4	30.0	135.6	26.9	135.6	26.9	109.4	24.8	110.4	24.8	91.5	23.3	93.3	23.4	78.6	22.2
50	18	160.3	31.8	123.9	28.9	123.9	28.9	100.0	27.0	100.9	27.1	83.7	25.7	85.3	25.8	71.9	24.7
50	20	150.3	33.0	116.1	30.3	116.1	30.3	93.7	28.5	94.6	28.6	78.4	27.2	79.9	27.3	67.3	26.3
50	22	140.2	34.2	108.4	31.7	108.4	31.7	87.4	30.0	88.2	30.0	73.2	28.8	74.6	28.9	62.8	27.9
50	24	130.1	35.4	100.6	33.0	100.6	33.0	81.1	31.4	81.9	31.5	67.9	30.3	69.2	30.4	58.3	29.5
55	15	200.5	31.9	155.0	28.4	155.0	28.4	125.0	26.0	126.2	26.1	104.7	24.4	106.7	24.5	89.9	23.2
55	18	185.5	33.8	143.3	30.5	143.3	30.5	115.6	28.3	116.7	28.4	96.8	26.7	98.6	26.9	83.1	25.6
55	20	175.4	35.0	135.6	31.9	135.6	31.9	109.4	29.8	110.4	29.8	91.5	28.3	93.3	28.4	78.6	27.2
55	22	165.3	36.2	127.8	33.2	127.8	33.2	103.1	31.2	104.1	31.3	86.3	29.9	87.9	30.0	74.1	28.9
55	24	155.3	37.4	120.0	34.6	120.0	34.6	96.8	32.7	97.7	32.8	81.0	31.4	82.6	31.6	69.6	30.5



Thermal output on the basis of DIN EN 1264



Maximum surface temperatures according to DIN EN 1264
 Central zone (AZ): 29 °C | Bathrooms: 33 °C | Edge zone (RZ, max. width 100 cm): 35 °C

Thermal output

Dry construction system Alu / Eco

ESTRICHZIEGEL® CREAPUR

Nominal layer thickness	20 mm
Thermal conductivity λ	0.67 W / mK
Spread σ	5 K

Flooring $R_{\lambda,B} = 0.00 \text{ m}^2 \text{ K} / \text{W}$ Tiles
 Flooring $R_{\lambda,B} = 0.05 \text{ m}^2 \text{ K} / \text{W}$ Parquet, Laminate, Synthetic fibre
 Flooring $R_{\lambda,B} = 0.10 \text{ m}^2 \text{ K} / \text{W}$ Carpet
 Flooring $R_{\lambda,B} = 0.15 \text{ m}^2 \text{ K} / \text{W}$ Velour, Ready-to-lay parquet, Floorboards

Average heating water temperature	Room temperature	Flooring $R_{\lambda,B} = 0.00 \text{ m}^2 \text{ K} / \text{W}$ Tiles				Flooring $R_{\lambda,B} = 0.05 \text{ m}^2 \text{ K} / \text{W}$ Parquet, Laminate, Synthetic fibre				Flooring $R_{\lambda,B} = 0.10 \text{ m}^2 \text{ K} / \text{W}$ Carpet				Flooring $R_{\lambda,B} = 0.15 \text{ m}^2 \text{ K} / \text{W}$ Velour, Ready-to-lay parquet, Floorboards			
		VA = 125 mm	Surface temperature	VA = 250 mm	Surface temperature	VA = 125 mm	Surface temperature	VA = 250 mm	Surface temperature	VA = 125 mm	Surface temperature	VA = 250 mm	Surface temperature	VA = 125 mm	Surface temperature	VA = 250 mm	Surface temperature
θ_m	θ_i	RZ	θ_F	AZ	θ_F	RZ	θ_F	AZ	θ_F	RZ	θ_F	AZ	θ_F	RZ	θ_F	AZ	θ_F
°C	°C	W / m ²	°C	W / m ²	°C	W / m ²	°C	W / m ²	°C	W / m ²	°C	W / m ²	°C	W / m ²	°C	W / m ²	°C
30	15	100.6	24.0	76.5	22.1	71.9	21.7	57.8	20.5	56.0	20.3	46.5	19.5	45.9	19.4	38.9	18.8
30	18	80.1	25.3	60.9	23.7	57.2	23.4	46.0	22.4	44.6	22.3	37.0	21.6	36.5	21.6	31.0	21.1
30	20	66.3	26.2	50.4	24.8	47.4	24.6	38.1	23.7	36.9	23.6	30.6	23.1	30.2	23.0	25.6	22.6
30	22	52.3	27.0	39.8	25.9	37.4	25.7	30.1	25.0	29.2	24.9	24.2	24.5	23.9	24.4	20.3	24.1
30	24	38.1	27.7	29.0	26.9	27.3	26.8	21.9	26.3	21.2	26.2	17.6	25.9	17.4	25.8	14.8	25.6
35	15	134.7	26.8	102.5	24.2	96.3	23.7	77.4	22.1	75.0	21.9	62.3	20.8	61.5	20.8	52.1	20.0
35	18	114.3	28.2	86.9	25.9	81.7	25.5	65.7	24.1	63.6	24.0	52.8	23.0	52.1	23.0	44.2	22.3
35	20	100.6	29.0	76.5	27.1	71.9	26.7	57.8	25.5	56.0	25.3	46.5	24.5	45.9	24.4	38.9	23.8
35	22	86.9	29.9	66.1	28.2	62.1	27.8	49.9	26.8	48.4	26.7	40.2	25.9	39.7	25.9	33.6	25.3
35	24	73.2	30.8	55.7	29.3	52.3	29.0	42.0	28.1	40.7	28.0	33.8	27.4	33.4	27.3	28.3	26.9
40	15	168.7	29.5	128.3	26.3	120.6	25.7	96.9	23.7	93.9	23.5	78.0	22.2	77.0	22.1	65.3	21.1
40	18	148.3	30.9	112.8	28.0	106.0	27.5	85.2	25.8	82.6	25.6	68.6	24.4	67.7	24.3	57.4	23.4
40	20	134.7	31.8	102.5	29.2	96.3	28.7	77.4	27.1	75.0	26.9	62.3	25.8	61.5	25.8	52.1	25.0
40	22	121.1	32.7	92.1	30.3	86.6	29.9	69.6	28.5	67.4	28.3	56.0	27.3	55.3	27.2	46.9	26.5
40	24	107.4	33.6	81.7	31.5	76.8	31.1	61.7	29.8	59.8	29.6	49.7	28.8	49.0	28.7	41.6	28.1
45	15	202.6	32.1	154.1	28.3	144.9	27.6	116.4	25.3	112.8	25.0	93.7	23.5	92.5	23.4	78.4	22.2
45	18	182.3	33.5	138.7	30.1	130.3	29.4	104.7	27.4	101.5	27.1	84.3	25.7	83.2	25.6	70.5	24.6
45	20	168.7	34.5	128.3	31.3	120.6	30.7	96.9	28.7	93.9	28.5	78.0	27.2	77.0	27.1	65.3	26.1
45	22	155.1	35.4	118.0	32.5	110.9	31.9	89.1	30.1	86.4	29.9	71.7	28.6	70.8	28.6	60.0	27.7
45	24	141.5	36.3	107.6	33.6	101.2	33.1	81.3	31.5	78.8	31.2	65.4	30.1	64.6	30.0	54.8	29.2
50	15	236.5	34.7	179.9	30.3	169.1	29.5	135.9	26.9	131.7	26.6	109.4	24.8	108.0	24.6	91.5	23.3
50	18	216.2	36.1	164.5	32.1	154.6	31.4	124.2	29.0	120.4	28.7	100.0	27.0	98.7	26.9	83.7	25.7
50	20	202.6	37.1	154.1	33.3	144.9	32.6	116.4	30.3	112.8	30.0	93.7	28.5	92.5	28.4	78.4	27.2
50	22	189.1	38.1	143.8	34.5	135.2	33.8	108.6	31.7	105.3	31.4	87.4	30.0	86.3	29.9	73.2	28.8
50	24	175.5	39.0	133.5	35.7	125.5	35.1	100.8	33.1	97.7	32.8	81.1	31.4	80.1	31.4	67.9	30.3
55	15	270.4	37.2	205.7	32.3	193.3	31.4	155.4	28.4	150.6	28.1	125.0	26.0	123.4	25.9	104.7	24.4
55	18	250.1	38.7	190.3	34.1	178.8	33.3	143.7	30.5	139.3	30.2	115.6	28.3	114.2	28.1	96.8	26.7
55	20	236.5	39.7	179.9	35.3	169.1	34.5	135.9	31.9	131.7	31.6	109.4	29.8	108.0	29.6	91.5	28.3
55	22	223.0	40.7	169.6	36.5	159.4	35.7	128.1	33.3	124.2	33.0	103.1	31.2	101.8	31.1	86.3	29.9
55	24	209.4	41.6	159.3	37.7	149.7	37.0	120.3	34.6	116.6	34.3	96.8	32.7	95.6	32.6	81.0	31.4



Thermal output on the basis of DIN EN 1264



Maximum surface temperatures according to DIN EN 1264
 Central zone (AZ): 29 °C | Bathrooms: 33 °C | Edge zone (RZ, max. width 100 cm): 35 °C

Thermal output

Dry construction system Alu / Eco

Dry screed element (Fermacell 25 mm)

Nominal layer thickness 25 mm
 Thermal conductivity λ 0.28 W / mK
 Spread σ 5 K

Flooring $R_{A,B} = 0.00 \text{ m}^2 \text{ K} / \text{W}$ Tiles
 Flooring $R_{A,B} = 0.05 \text{ m}^2 \text{ K} / \text{W}$ Parquet, Laminate, Synthetic fibre
 Flooring $R_{A,B} = 0.10 \text{ m}^2 \text{ K} / \text{W}$ Carpet
 Flooring $R_{A,B} = 0.15 \text{ m}^2 \text{ K} / \text{W}$ Velour, Ready-to-lay parquet, Floorboards

Average heating water temperature	Room temperature	Tiles				Parquet, Laminate, Synthetic fibre				Carpet				Velour, Ready-to-lay parquet, Floorboards			
		VA = 125 mm	Surface temperature	VA = 250 mm	Surface temperature	VA = 125 mm	Surface temperature	VA = 250 mm	Surface temperature	VA = 125 mm	Surface temperature	VA = 250 mm	Surface temperature	VA = 125 mm	Surface temperature	VA = 250 mm	Surface temperature
θ_m	θ_i	RZ	θ_F	AZ	θ_F	RZ	θ_F	AZ	θ_F	RZ	θ_F	AZ	θ_F	RZ	θ_F	AZ	θ_F
°C	°C	W / m ²	°C	W / m ²	°C	W / m ²	°C	W / m ²	°C	W / m ²	°C	W / m ²	°C	W / m ²	°C	W / m ²	°C
30	15	67.5	21.3	52.6	20.0	53.2	20.1	43.1	19.2	44.0	19.3	36.6	18.6	37.6	18.7	31.7	18.2
30	18	53.7	23.1	41.9	22.1	42.3	22.1	34.3	21.4	35.0	21.5	29.1	20.9	29.9	21.0	25.2	20.6
30	20	44.4	24.3	34.6	23.4	35.0	23.5	28.4	22.9	29.0	22.9	24.1	22.5	24.8	22.5	20.8	22.2
30	22	35.1	25.5	27.4	24.8	34.9	25.5	22.4	24.3	22.9	24.4	19.0	24.0	19.6	24.0	16.5	23.7
30	24	25.6	26.6	19.9	26.1	20.2	26.1	16.3	25.7	16.7	25.8	13.9	25.5	14.3	25.5	12.0	25.3
35	15	90.3	23.2	70.4	21.5	71.2	21.6	57.7	20.5	58.9	20.6	48.9	19.7	50.3	19.8	42.4	19.1
35	18	76.6	25.1	59.7	23.6	60.4	23.7	48.9	22.7	50.0	22.8	41.5	22.0	42.7	22.2	35.9	21.5
35	20	67.5	26.3	52.6	25.0	53.2	25.1	43.1	24.2	44.0	24.3	36.6	23.6	37.6	23.7	31.7	23.2
35	22	58.3	27.5	45.4	26.4	46.0	26.4	37.2	25.7	38.0	25.7	31.6	25.2	32.5	25.2	27.3	24.8
35	24	49.1	28.7	38.3	27.8	38.7	27.8	31.3	27.1	32.0	27.2	26.6	26.7	27.3	26.8	23.0	26.4
40	15	113.1	25.1	88.2	23.0	89.2	23.1	72.3	21.7	73.8	21.8	61.3	20.8	63.0	20.9	53.1	20.1
40	18	99.4	27.0	77.5	25.1	78.4	25.2	63.5	24.0	64.8	24.1	53.9	23.1	55.4	23.3	46.7	22.5
40	20	90.3	28.2	70.4	26.5	71.2	26.6	57.7	25.5	58.9	25.6	48.9	24.7	50.3	24.8	42.4	24.1
40	22	81.2	29.4	63.3	27.9	64.0	28.0	51.9	27.0	52.9	27.0	44.0	26.3	45.2	26.4	38.1	25.7
40	24	72.0	30.7	56.2	29.3	56.8	29.4	46.0	28.4	47.0	28.5	39.0	27.8	40.1	27.9	33.8	27.4
45	15	135.9	26.9	106.0	24.5	107.2	24.6	86.8	22.9	88.6	23.1	73.6	21.8	75.7	22.0	63.8	21.0
45	18	122.2	28.8	95.3	26.6	96.4	26.7	78.1	25.2	79.7	25.3	66.2	24.2	68.1	24.3	57.3	23.4
45	20	113.1	30.1	88.2	28.0	89.2	28.1	72.3	26.7	73.8	26.8	61.3	25.8	63.0	25.9	53.1	25.1
45	22	104.0	31.3	81.1	29.4	82.0	29.5	66.4	28.2	67.8	28.3	56.4	27.3	58.0	27.5	48.8	26.7
45	24	94.9	32.6	74.0	30.8	74.8	30.9	60.6	29.7	61.9	29.8	51.4	28.9	52.9	29.0	44.5	28.3
50	15	158.6	28.7	123.7	25.9	125.1	26.0	101.3	24.1	103.4	24.3	86.0	22.8	88.4	23.0	74.4	21.9
50	18	145.0	30.6	113.0	28.1	114.3	28.2	92.6	26.4	94.5	26.5	78.6	25.2	80.8	25.4	68.0	24.3
50	20	135.9	31.9	106.0	29.5	107.2	29.6	86.8	27.9	88.6	28.1	73.6	26.8	75.7	27.0	63.8	26.0
50	22	126.8	33.2	98.9	30.9	100.0	31.0	81.0	29.4	82.7	29.6	68.7	28.4	70.7	28.6	59.5	27.6
50	24	117.7	34.4	91.8	32.3	92.8	32.4	75.2	30.9	76.7	31.1	63.8	30.0	65.6	30.1	55.2	29.2
55	15	181.4	30.5	141.4	27.3	143.0	27.5	115.8	25.3	118.2	25.5	98.3	23.9	101.1	24.1	85.1	22.8
55	18	167.7	32.4	130.8	29.5	132.3	29.6	107.1	27.6	109.4	27.8	90.9	26.2	93.5	26.5	78.7	25.2
55	20	158.6	33.7	123.7	30.9	125.1	31.0	101.3	29.1	103.4	29.3	86.0	27.8	88.4	28.0	74.4	26.9
55	22	149.5	35.0	116.6	32.3	117.9	32.5	95.5	30.6	97.5	30.8	81.0	29.4	83.3	29.6	70.2	28.5
55	24	140.4	36.3	109.5	33.8	110.7	33.9	89.7	32.2	91.6	32.3	76.1	31.0	78.3	31.2	65.9	30.2



Thermal output on the basis of DIN EN 1264



Maximum surface temperatures according to DIN EN 1264
 Central zone (AZ): 29 °C | Bathrooms: 33 °C | Edge zone (RZ, max. width 100 cm): 35 °C

Thermal output

Dry construction system Alu / Eco Cement screed CT

Nominal layer thickness	45 mm
Thermal conductivity λ	1.2 W / mK
Spread σ	5 K

Flooring $R_{A,B} = 0.00 \text{ m}^2 \text{ K} / \text{W}$ Tiles
 Flooring $R_{A,B} = 0.05 \text{ m}^2 \text{ K} / \text{W}$ Parquet, Laminate, Synthetic fibre
 Flooring $R_{A,B} = 0.10 \text{ m}^2 \text{ K} / \text{W}$ Carpet
 Flooring $R_{A,B} = 0.15 \text{ m}^2 \text{ K} / \text{W}$ Velour, Ready-to-lay parquet, Floorboards

Average heating water temperature	Room temperature	Tiles				Parquet, Laminate, Synthetic fibre				Carpet				Velour, Ready-to-lay parquet, Floorboards			
		VA = 125 mm	Surface temperature	VA = 250 mm	Surface temperature	VA = 125 mm	Surface temperature	VA = 250 mm	Surface temperature	VA = 125 mm	Surface temperature	VA = 250 mm	Surface temperature	VA = 125 mm	Surface temperature	VA = 250 mm	Surface temperature
θ_m	θ_i	RZ	θ_F	AZ	θ_F	RZ	θ_F	AZ	θ_F	RZ	θ_F	AZ	θ_F	RZ	θ_F	AZ	θ_F
°C	°C	W / m ²	°C	W / m ²	°C	W / m ²	°C	W / m ²	°C	W / m ²	°C	W / m ²	°C	W / m ²	°C	W / m ²	°C
30	15	96.6	23.7	74.6	21.9	69.8	21.5	56.8	20.4	54.8	20.2	45.8	19.4	45.2	19.4	38.5	18.8
30	18	76.9	25.1	59.4	23.6	55.6	23.3	45.2	22.4	43.6	22.2	36.4	21.6	35.9	21.5	30.6	21.1
30	20	63.6	26.0	49.1	24.7	46.0	24.4	37.4	23.7	36.1	23.6	30.1	23.0	29.8	23.0	25.4	22.6
30	22	50.3	26.8	38.8	25.8	34.9	25.5	29.5	25.0	28.5	24.9	23.8	24.4	23.5	24.4	20.0	24.1
30	24	36.6	27.6	28.3	26.9	26.5	26.7	21.5	26.2	20.8	26.2	17.4	25.8	17.1	25.8	14.6	25.6
35	15	129.3	26.4	99.9	24.0	93.5	23.5	76.0	22.0	73.4	21.8	61.3	20.8	60.5	20.7	51.5	19.9
35	18	109.7	27.8	84.7	25.7	79.3	25.3	64.5	24.0	62.3	23.8	52.0	23.0	51.3	22.9	43.7	22.2
35	20	96.6	28.7	74.6	26.9	69.8	26.5	56.8	25.4	54.8	25.2	45.8	24.4	45.2	24.4	38.5	23.8
35	22	83.4	29.6	64.4	28.0	60.3	27.7	49.0	26.7	47.4	26.6	39.5	25.9	39.0	25.8	33.3	25.3
35	24	70.3	30.5	54.3	29.2	50.8	28.9	41.3	28.0	39.9	27.9	33.3	27.3	32.9	27.3	28.0	26.8
40	15	162.0	28.9	125.1	26.0	117.1	25.4	95.2	23.6	91.9	23.3	76.7	22.1	75.7	22.0	64.5	21.0
40	18	142.4	30.4	110.0	27.8	103.0	27.2	83.7	25.7	80.8	25.4	67.5	24.3	66.6	24.2	56.7	23.4
40	20	129.3	31.4	99.9	29.0	93.5	28.5	76.0	27.0	73.4	26.8	61.3	25.8	60.5	25.7	51.5	24.9
40	22	116.2	32.3	89.8	30.2	84.1	29.7	68.3	28.4	66.0	28.2	55.1	27.2	54.4	27.2	46.3	26.5
40	24	103.1	33.3	79.7	31.3	74.6	30.9	60.6	29.7	58.6	29.5	48.9	28.7	48.2	28.6	41.1	28.0
45	15	194.5	31.5	150.3	28.0	140.7	27.3	114.3	25.2	110.4	24.8	92.2	23.4	91.0	23.3	77.5	22.1
45	18	175.0	33.0	135.2	29.8	126.5	29.1	102.8	27.2	99.3	26.9	82.9	25.6	81.8	25.5	69.7	24.5
45	20	162.0	33.9	125.1	31.0	117.1	30.4	95.2	28.6	91.9	28.3	76.7	27.1	75.7	27.0	64.5	26.0
45	22	148.9	34.9	115.0	32.2	107.7	31.6	87.5	30.0	84.5	29.7	70.6	28.6	69.6	28.5	59.3	27.6
45	24	135.9	35.9	104.9	33.4	98.2	32.9	79.8	31.3	77.1	31.1	64.4	30.0	63.5	30.0	54.1	29.2
50	15	227.1	34.0	175.4	30.0	164.2	29.1	133.5	26.7	128.9	26.3	107.6	24.6	106.2	24.5	90.5	23.2
50	18	207.6	35.5	160.3	31.8	150.1	31.0	122.0	28.8	117.8	28.4	98.4	26.9	97.1	26.8	82.7	25.6
50	20	194.5	36.5	150.3	33.0	140.7	32.3	114.3	30.2	110.4	29.8	92.2	28.4	91.0	28.3	77.5	27.1
50	22	181.5	37.5	140.2	34.2	131.2	33.5	106.7	31.5	103.0	31.2	86.0	29.8	84.9	29.8	72.3	28.7
50	24	168.5	38.5	130.1	35.4	121.8	34.8	99.0	32.9	95.6	32.6	79.8	31.3	78.8	31.2	67.1	30.3
55	15	259.7	36.4	200.5	31.9	187.8	31.0	152.6	28.2	147.4	27.8	123.0	25.9	121.4	25.7	103.5	24.3
55	18	240.1	38.0	185.5	33.8	173.6	32.9	141.1	30.3	136.3	29.9	113.8	28.1	112.3	28.0	95.7	26.6
55	20	227.1	39.0	175.4	35.0	164.2	34.1	133.5	31.7	128.9	31.3	107.6	29.6	106.2	29.5	90.5	28.2
55	22	214.1	40.0	165.3	36.2	154.8	35.4	125.8	33.1	121.5	32.7	101.4	31.1	100.1	31.0	85.3	29.8
55	24	201.1	41.0	155.3	37.4	145.4	36.6	118.2	34.5	114.1	34.1	95.3	32.6	94.0	32.5	80.1	31.4



Thermal output on the basis of DIN EN 1264



Maximum surface temperatures according to DIN EN 1264
 Central zone (AZ): 29 °C | Bathrooms: 33 °C | Edge zone (RZ, max. width 100 cm): 35 °C

Thermal output

Dry construction system Alu / Eco

Tiled screed CAF-F5

Nominal layer thickness 35 mm
 Thermal conductivity λ 1.6 W / mK
 Spread σ 5 K

Flooring $R_{\lambda,B} = 0.00 \text{ m}^2 \text{ K} / \text{W}$ Tiles
 Flooring $R_{\lambda,B} = 0.05 \text{ m}^2 \text{ K} / \text{W}$ Parquet, Laminate, Synthetic fibre
 Flooring $R_{\lambda,B} = 0.10 \text{ m}^2 \text{ K} / \text{W}$ Carpet
 Flooring $R_{\lambda,B} = 0.15 \text{ m}^2 \text{ K} / \text{W}$ Velour, Ready-to-lay parquet, Floorboards

Average heating water temperature	Room temperature	Tiles				Parquet, Laminate, Synthetic fibre				Carpet				Velour, Ready-to-lay parquet, Floorboards			
		VA = 125 mm	Surface temperature	VA = 250 mm	Surface temperature	VA = 125 mm	Surface temperature	VA = 250 mm	Surface temperature	VA = 125 mm	Surface temperature	VA = 250 mm	Surface temperature	VA = 125 mm	Surface temperature	VA = 250 mm	Surface temperature
θ_m	θ_r	RZ	θ_f	AZ	θ_f	RZ	θ_f	AZ	θ_f	RZ	θ_f	AZ	θ_f	RZ	θ_f	AZ	θ_f
°C	°C	W / m ²	°C	W / m ²	°C	W / m ²	°C	W / m ²	°C	W / m ²	°C	W / m ²	°C	W / m ²	°C	W / m ²	°C
30	15	110.7	24.9	85.1	22.8	76.8	22.1	62.6	20.9	59.0	20.6	49.5	19.7	48.0	19.6	41.0	19.0
30	18	88.1	26.0	67.8	24.3	61.1	23.8	49.8	22.8	46.9	22.5	39.4	21.9	38.2	21.8	32.6	21.3
30	20	72.9	26.8	56.1	25.3	50.6	24.8	41.2	24.0	38.9	23.8	32.6	23.2	31.6	23.2	27.0	22.7
30	22	57.6	27.4	44.3	26.3	34.9	25.5	32.6	25.2	30.7	25.1	25.7	24.6	25.0	24.5	21.3	24.2
30	24	42.0	28.1	32.3	27.2	29.1	26.9	23.7	26.4	22.4	26.3	18.8	26.0	18.2	25.9	15.6	25.7
35	15	148.2	27.9	114.0	25.1	102.9	24.2	83.8	22.7	79.0	22.3	66.3	21.2	64.3	21.0	54.9	20.2
35	18	125.7	29.1	96.7	26.7	87.3	25.9	71.1	24.6	67.0	24.3	56.2	23.3	54.5	23.2	46.6	22.5
35	20	110.7	29.9	85.1	27.8	76.8	27.1	62.6	25.9	59.0	25.6	49.5	24.7	48.0	24.6	41.0	24.0
35	22	95.6	30.6	73.6	28.8	66.4	28.2	54.0	27.1	51.0	26.9	42.8	26.2	41.5	26.0	35.4	25.5
35	24	80.5	31.4	61.9	29.8	55.9	29.3	45.5	28.4	42.9	28.2	36.0	27.6	34.9	27.5	29.8	27.0
40	15	185.6	30.8	142.8	27.4	128.8	26.3	104.9	24.4	98.9	23.9	83.0	22.6	80.5	22.4	68.8	21.4
40	18	163.2	32.0	125.5	29.1	113.2	28.1	92.2	26.4	87.0	25.9	72.9	24.8	70.8	24.6	60.5	23.7
40	20	148.2	32.9	114.0	30.1	102.9	29.2	83.8	27.7	79.0	27.3	66.3	26.2	64.3	26.0	54.9	25.2
40	22	133.2	33.7	102.5	31.2	92.5	30.4	75.3	29.0	71.0	28.6	59.6	27.6	57.8	27.5	49.4	26.7
40	24	118.2	34.5	90.9	32.3	82.0	31.5	66.8	30.2	63.0	29.9	52.8	29.0	51.3	28.9	43.8	28.2
45	15	223.0	33.7	171.5	29.7	154.7	28.4	126.0	26.1	118.8	25.5	99.7	24.0	96.7	23.7	82.6	22.6
45	18	200.6	34.9	154.3	31.3	139.2	30.2	113.3	28.1	106.9	27.6	89.7	26.1	87.0	25.9	74.3	24.9
45	20	185.6	35.8	142.8	32.4	128.8	31.3	104.9	29.4	98.9	28.9	83.0	27.6	80.5	27.4	68.8	26.4
45	22	170.7	36.6	131.3	33.5	118.4	32.5	96.4	30.7	90.9	30.3	76.3	29.0	74.0	28.8	63.2	27.9
45	24	155.7	37.5	119.8	34.6	108.1	33.7	88.0	32.0	83.0	31.6	69.6	30.5	67.5	30.3	57.7	29.5
50	15	260.3	36.5	200.2	31.9	180.6	30.4	147.1	27.8	138.7	27.1	116.4	25.3	112.9	25.0	96.4	23.7
50	18	237.9	37.8	183.0	33.6	165.1	32.2	134.4	29.8	126.8	29.2	106.3	27.5	103.1	27.3	88.1	26.0
50	20	223.0	38.7	171.5	34.7	154.7	33.4	126.0	31.1	118.8	30.5	99.7	29.0	96.7	28.7	82.6	27.6
50	22	208.0	39.5	160.0	35.8	144.4	34.6	117.6	32.4	110.9	31.9	93.0	30.4	90.2	30.2	77.1	29.1
50	24	193.1	40.4	148.5	36.9	134.0	35.7	109.1	33.7	102.9	33.2	86.3	31.9	83.7	31.7	71.5	30.6
55	15	297.6	39.2	228.9	34.1	206.5	32.4	168.2	29.4	158.6	28.7	133.0	26.7	129.0	26.3	110.3	24.8
55	18	275.2	40.6	211.7	35.8	191.0	34.2	155.5	31.4	146.7	30.7	123.0	28.9	119.3	28.6	102.0	27.2
55	20	260.3	41.5	200.2	36.9	180.6	35.4	147.1	32.8	138.7	32.1	116.4	30.3	112.9	30.0	96.4	28.7
55	22	245.4	42.3	188.7	38.0	170.3	36.6	138.7	34.1	130.8	33.5	109.7	31.8	106.4	31.5	90.9	30.3
55	24	230.4	43.2	177.2	39.1	159.9	37.8	130.2	35.4	122.8	34.8	103.0	33.2	99.9	33.0	85.4	31.8



Thermal output on the basis of DIN EN 1264



Maximum surface temperatures according to DIN EN 1264
 Central zone (AZ): 29 °C | Bathrooms: 33 °C | Edge zone (RZ, max. width 100 cm): 35 °C

3.2 Dry construction system - Eco

Excellent insulation with ecological materials are making a sustainable construction possible. The dry construction system - Eco is fast and easy to install and stands out with excellent noise cancelling behavior.

Areas of application

Old and new buildings
 Industrial buildings
 Passive house systems
 Perfect for energy-saving heat pumps
 Solar energy and condensing boiler technology



System components

Description/Dim.	Dry construction element	
	Eco-VA 12,5	Eco-VA 25
Code	51.913.030	51.913.031
Thickness of plate	30 mm	30 mm
Thickness of insulation	30 mm	30 mm
Compressionability	0	0
Thermal conductivity group	WLG 040	WLG 040
Thermal conductivity in accordance with DIN 4108	0.040 W/mK	0.040 W/mK
Thermal resistance	0.75 m ² K/W	0.75 m ² K/W
Compressive strength	mind. 140 kPA	mind. 140 kPA
Material	wood fibre / Alu	wood fibre / Alu
Applicable norms	DIN 68755 DIN 18165-1	DIN 68755 DIN 18165-1
Field of application	DEO	DEO
Building material class DIN 4102	B2	B2
Installation gap	12.5 cm	25 cm
PU	5 pcs	5 pcs
Size	1.00 m x 0.5 m	1.00 m x 0.5 m

Installation instructions



The edge insulation strip must be fixed onto the walls.



The turn plates as well as the turn elements must be laid in accordance with the plan and the geometrical characteristics of the room. Eventually needed filling elements can be easily cutted and put into the middle of the flooring.



Individual pipe guidances can be layed with the available turn plates.



Beginning from the manifold the pipe must be installed into the pipe guidance of the heat conducting surface. A multilayer composite pipe with aluminium must be chosen when installing the dry construction system.



The entire surface can be covered with PE-Foil as a sliding surface. After doing so the dry concrete plates can be installed in accordance with the manufacturers guidelines.



At the very last the heating circuits can be connected to the manifold.

3.3 Renovation system (Mini)

The MAINFLOOR renovation system (Mini) can be laid directly on existing surfaces such as screed, tiles or wooden flooring.

Areas of application

Residential and office buildings
 Medical practices
 Detached houses

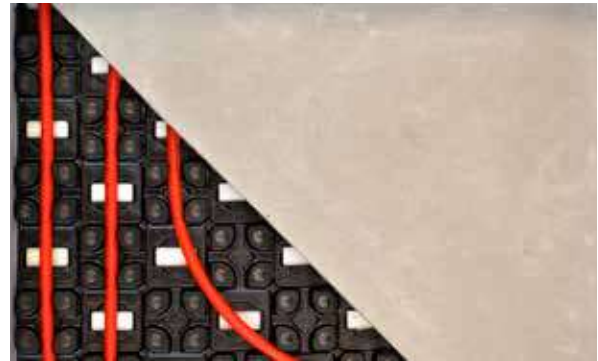

System components

Product designation	Plastic pipe PE-Xc	PE-RT plastic pipe
Code	12.010.220	501.000.312.00
Dimensions	10 x 1.3	10 x 1.3
Colour	red	natural
Max. temperature load	90°C	90°C
Max. continuous temperature load	70°C	70°C
Max. operating pressure at 70°C	8 bar	6 bar
Application class (ISO 10508)	Class 4/8	Class 4/6
Water capacity l/running metre	0.043	0.043
Packaging unit	200 m	200 m
Verlegungslänge	60 m	60 m

Useful load up to 3 kN/m², concentrated load up to 2kN

Product designation	Pipe positioning plate
Code	51.903.160
Packaging unit	16 pcs = 9.6 m ²
Pipe diameter	10 - 12 mm
Gross panel area	1.050 m x 650 mm
Usable panel area	0.6 m ²
Pipe positioning element height	16 mm
Material	PS
Colour	black

Installation instructions

Prior to installation of the renovation system, the subfloor must be checked for sufficient load-bearing capacity by the contractor! The subfloor must be firm, clean (free from grease and cleaning agents) and free from cracks. Cracks must be filled with resin if necessary and any unevenness (isolated ridges, pipes, cables) removed. The type of priming depends on the material of the old substrate. Wood surfaces require special attention, joints must be sealed, primed with special primer, levelled with a 2 mm thick floor-levelling compound and primed twice with screed primer. The manufacturer's instructions must be observed in any event!



Fixing insulation strip to walls.



Remove about 10 cm of the protective foil, fix the pipe support foil element including protective foil to the semicircular profiles in the left corner of the room. Slowly remove the protective foil and fix to the floor. Place the next pipe support foil elements with the semicircular profiles over the outer row of the closed side, connect the plates and remove the protective foil as for the first plate. If adhesion to the floor is insufficient, fixing can take place mechanically if required.



Fast one-man laying of PE-RT heating pipes. Self-aligning pipe guidance in profiles with 50 mm pitch and laying at a 45° angle with 70 mm pitch. Fill heating circuits and test under pressure.



Pouring filling compound.



Dry heating with max. 45°C. Accessible in accordance with manufacturers manual (screed).

Renovation system installation examples

The MAINFLOOR renovation system can be installed on different substrates and in different designs. The manufacturer's instructions and pertinent standards must be observed for installation of the system!

The subfloor must be sound and dimensionally stable, crack and vibration-free, firm, dry and clean. The underfloor heating must not be switched on while laying the screed and the subfloor must be at normal room temperature.

Compound installation on screed or tiles

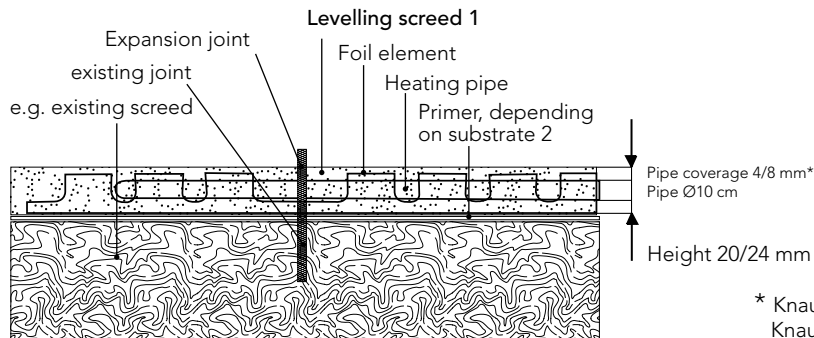

* Knauf N440 (Knauf 425): 8 mm Pipe coverage
Knauf N430 (Knauf 430): 4 mm Pipe coverage

On insulation - solid floor

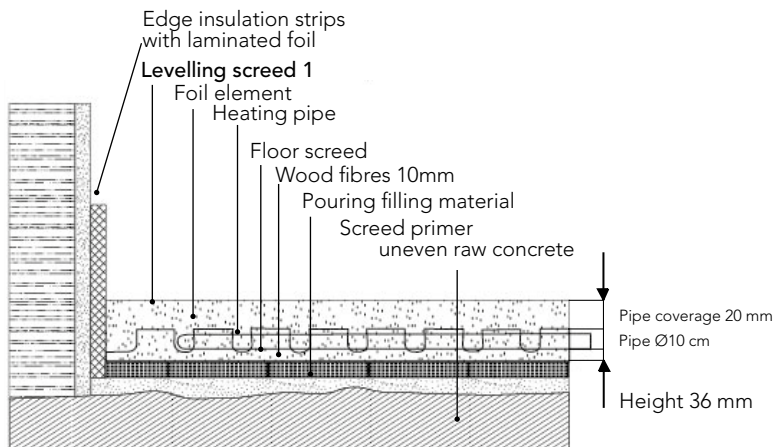

Wood beam flooring

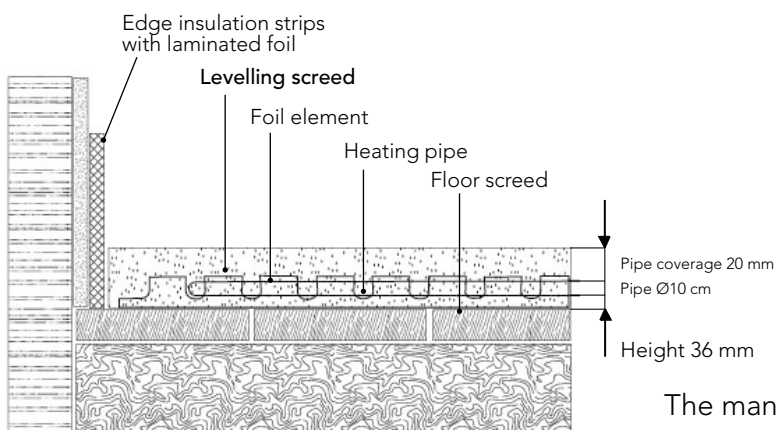

The manufacturers' instructions are binding!
(Knauf:FE22.de)

Processing example with Knauf levelling screed N440 (former 425)

The renovation system must be installed as previously described. This processing example is based on the technical directive F422.de of Knauf. Observe the manufacturer's instructions for processing.

The graph below shows a preparatory heat-up phase for a layer thickness of 20 mm. The floor is ready for foot traffic after seven days. If a separating layer is to be installed, this is extended by two days. Readiness for foot traffic is given from a CM residual moisture of 0.5%. If the residual moisture is not reached - heating and ventilation must be continued (In accordance with the surface temperature 15 - 18°C)

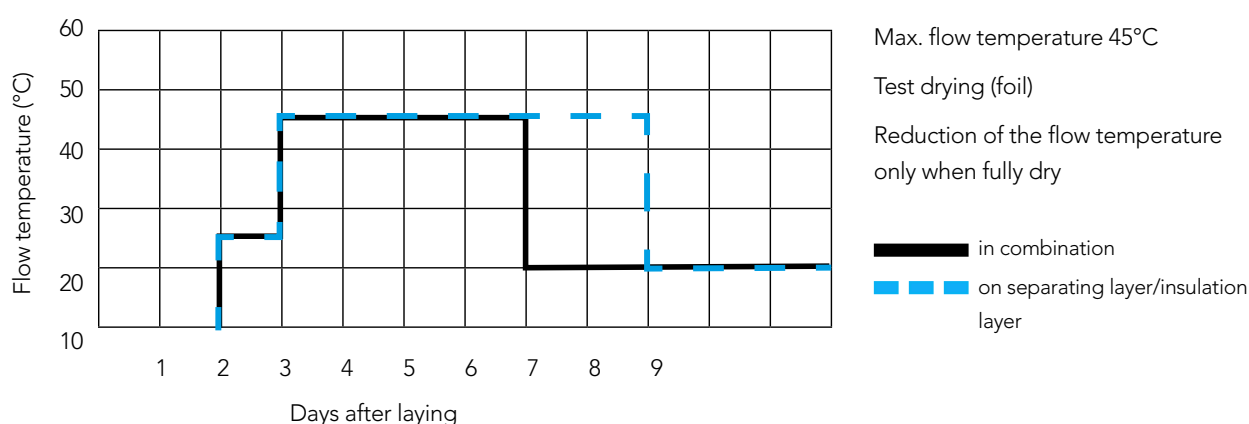

Top coverings	Composite construction	Screed on insulation layer or separating layer
Textile	Without restriction	Without restriction
Elastic	Without restriction	Without restriction
Tiles und Platten	Without restriction	Ceramic tiles up to 60 cm x 60 cm Natural stone up to 40 cm x 40 cm
Parquet	Without restriction	Mosaic-, multilayer hardwood flooring (other available on request)
Floating flooring	Without restriction	Without restriction

Special screed layer thicknesses

Name	Bag size	Consumption	Thickness
Weber.Plan 813-10	25 kg	1.5 kg/m ² per 1 mm layer thickness	up to 10 mm
Weber.Plan 813-25	25 kg	1.5 kg/m ² per 1 mm layer thickness	up to 25 mm
Weber.Plan 813-40	25 kg	1.5 kg/m ² per 1 mm layer thickness	up to 40 mm
PCI-Periplan	25 kg	1.6 kg/m ² per 1 mm layer thickness	2 mm - 30 mm
Knauf N440	40 kg	1.8 kg/m ² per 1 mm layer thickness	see F422.de
Knauf N430	25 kg	1.6 kg/m ² per 1 mm layer thickness	see F423.de

3.4 Stapler system

The stapler system is the most popular method for laying underfloor heating systems. Free installation and uncomplicated handling make this method of installation a classic among underfloor heating systems. In conjunction with the MAINCOR insulation roll and foil, the U-clips are held securely. The MAINCOR stapler system is suitable for pipe sizes from 14 mm till 20 mm.

Areas of application

Old and new buildings
 Industrial buildings
 Passive house systems
 Radiant heating and cooling
 Cement and floating screed



System components

Product designation	Insulation roll 20-2	Insulation roll 25-2	Insulation roll 30-2	Fanfold board 30	U-clip
Code	50.903.034	50.903.252	50.903.020	50.903.023.5	50.903.021
Nominal thickness dl	20 mm	25 mm	30 mm	30 mm	-
Compressibility	2 mm	2 mm	2 mm	-	-
Thermal conductivity category	WLG 045	WLG 045	WLG 040	WLG 035	-
Thermal conductivity according to DIN 4108	0.045 W/mK	0.045 W/mK	0.040 W/mK	0.035 W/mK	-
Thermal resistance	0.44 m ² K/W	0.55 m ² K/W	0.75 m ² K/W	0.857 m ² K/W	-
Stiffness	20 MN/m ³	20 MN/m ³	20 MN/m ³	-	-
Impact sound level reduction	28 db	28 db	28 db	-	-
Traffic load	4 kPa	4 kPa	5 kPa	100 kPa	-
Material	EPS	EPS	EPS	EPS	-
Applicable standards	EN 13163 DIN 4108	EN 13163 DIN 4108	EN 13163 DIN 4108	EN 13163 DIN 4108	-
Designation according to standard	EPS-EN13163-L(3)- W(3)-T(1)-S(5)-P(5)- DS(N)5-BS50-SD20- CP2	EPS-EN13163-L(3)- W(3)-T(1)-S(5)-P(5)- DS(N)5-BS50-SD20- CP2	EPS-EN13163- L(3)-W(3)-T(1)-S(5)- P(5)-DS(N)5-BS50- SD20-CP2	EPS-EN13163-L(3)- W(3)-T(1)-S(5)-P(5)- DS(N)100-BS50	-
Area of application	DES sg	DES sg	DES sg	DEO	-
Quality control	CE/FIW	CE/FIW	CE/FIW	CE/FIW	-
Fire behaviour according to EN 13501	Class E	Class E	Class E	Class E	-
Building material class according to DIN 4102	B2	B2	B2	B2	-
Foil material	PP-fabric	PP-fabric	PP-fabric	PP-fabric	-
Protection against moisture according to DIN 18560	yes	yes	yes	yes	-
Foil overlap	30 mm	30 mm	30 mm	30 mm	-
Packaging unit	10 m ²	10 m ²	10 m ²	10 m ²	900 pcs
Dimensions	10 m x 1.0 m	10 m x 1.0 m	10 m x 1.0 m	2.0 m x 1.0 m	40 mm

Installation instructions



The edge insulation strip must be fixed to the walls.



The insulation roll is rolled out onto the sub-insulation. The joints and the skirt of the edge insulation strip are then taped. EN 4108 and especially in Germany the EnEV must be observed.



The pipe is uncoiled using the MAINCOR pipe decoiler and fixed in place with the tacker. For floating screeds, the pipes must be fixed closer together to prevent flotation. Specified minimum bending radii must be observed.

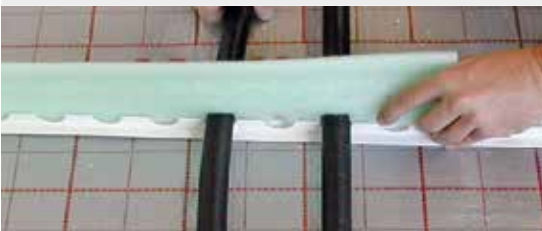

Expansion joints must comply with EN 1264.



The pipes are finally connected to the manifold.



Installation completed with the stapler system.

3.5 Rail system

The MAINCOR rail system can be combined with different types of insulation materials and insulation thicknesses. The pipes are simply clicked into the rails for quick and easy installation and can also be corrected after installation. The MAINCOR rail system is suitable for 14 to 20 mm pipes.

Areas of application

Old and new buildings
Wall and ceiling heating systems
Radiant heating and cooling
Cement and floating screed



System components

Product designation	Insulation roll 20-2	Insulation roll 25-2	Insulation roll 30-2	Fanfold board 30	Clip rail
Code	50.903.034	50.903.252	50.903.020	50.903.023.5	50.903.036
Nominal thickness dl	20 mm	25 mm	30 mm	30 mm	-
Compressibility	2 mm	2 mm	2 mm	-	-
Thermal conductivity category	WLG 045	WLG 045	WLG 040	WLG 035	-
Thermal conductivity according to DIN 4108	0.045 W/mK	0.045 W/mK	0.040 W/mK	0.035 W/mK	-
Thermal resistance	0.44 m ² K/W	0.55 m ² K/W	0.75 m ² K/W	0.857 m ² K/W	-
Stiffness	20 MN/m ³	20 MN/m ³	20 MN/m ³	-	-
Impact sound level reduction	28 db	28 db	28 db	-	-
Traffic load	4 kPa	4 kPa	5 kPa	100 kPa	-
Material	EPS	EPS	EPS	EPS	PP
Applicable standards	EN 13163 DIN 4108	EN 13163 DIN 4108	EN 13163 DIN 4108	EN 13163 DIN 4108	-
Designation according to standard	EPS-EN13163-L(3)- W(3)-T(1)-S(5)-P(5)- DS(N)5-BS50-SD20- CP2	EPS-EN13163-L(3)- W(3)-T(1)-S(5)-P(5)- DS(N)5-BS50-SD20- CP2	EPS-EN13163-L(3)- W(3)-T(1)-S(5)-P(5)- DS(N)5-BS50-SD20- CP2	EPS-EN13163-L(3)- W(3)-T(1)-S(5)-P(5)- DS(N)100-BS50	-
Area of application	DES sg	DES sg	DES sg	DEO	-
Quality control	CE/FIW	CE/FIW	CE/FIW	CE/FIW	-
Fire behaviour according to EN 13501	Class E	Class E	Class E	Class E	-
Building material class according to DIN 4102	B2	B2	B2	B2	-
Foil material	PP-fabric	PP-fabric	PP-fabric	PP-fabric	-
Protection against moisture according to DIN 18560	yes	yes	yes	yes	-
Foil overlap	30 mm	30 mm	30 mm	30 mm	-
Packaging unit	10 m ²	10 m ²	10 m ²	10 m ²	100 m
Dimensions	10 m x 1.0 m	10 m x 1.0 m	10 m x 1.0 m	2 m x 1 m	1 m x 3.8cm

Installation instructions



The edge insulation strip must be fixed to the walls.



The insulation roll is rolled out onto the sub-insulation. The joints and the skirt of the edge insulation strip are then taped. EN 4108 and especially in Germany the EnEV must be observed.



The MAINCOR rail system is simply bonded to the already laid insulation. The material requirement is 1m per m². The substrate must be dust-free for bonding.



The pipe is uncoiled using the MAINCOR pipe decoiler and simply clicked into the rails. Expansion joints must comply with EN 1264.



The laid pipes are connected to the manifold.



Example of an installation completed with the rail system with pipes laid in a meander pattern.

3.6 Pipe positioning panel system

The MAINCOR pipe positioning panel system is floating screed tight. The pipe positioning elements hold the heating pipes securely. The panels are tread resistant and designed for flexible pipe laying due to numerous additional elements. The MAINCOR pipe positioning panel system is suitable for 14 to 20 mm pipes.

Areas of application

Industrial buildings
Passive house systems
Cement and floating screed



System components

Product designation	Pipe positioning panel without Insulation	Premium pipe positioning panel	
		NP 11	NP 30-2
Code	51.903.060	51.903.061	51.903.062
Total thickness	-	31 mm	51 mm
Nominal insulation thickness	-	11 mm	30 mm
Compressibility	-	-	2 mm
Thermal conductivity category	-	WLG 035	WLG 040
Thermal conductivity according to DIN 4108	-	0.035 W/m ² K	0.040 W/m ² K
Thermal resistance	-	0.31 m ² K/W	0.75 m ² K/W
Stiffness	-	-	SD 20
Impact sound level reduction	-	-	28 db
Traffic load	N.A.	75 kPa	5 kPa
Material	PS	PS/EPS	PS/EPS
Applicable standards	EN 1264	EN 1264 EN 13163	EN 1264 EN 13163
Designation according to DIN EN 13163	-	EPS-EN13163- T1-L1-W1-S1-P3- DS(N)5-DLT(1)5- BS250-CS(10)150	EPS-EN13163- T1-L1-W1-S1-P3- DS(N)5-BS100- SD20-CP2
Area of application	-	DEO	DES sg
Fire behaviour according to EN 13501	Class E	Class E	Class E
Building material class according to DIN 4102	B2	B2	B2
Protection against moisture according to DIN 18560	yes	yes	yes
Packaging unit	12 pcs	13 pcs	6 pcs
Usable panel area	1.4 m x 0.8 m	1.4 m x 0.8 m	1.4 m x 0.8 m
Gross panel area	1.45 m x 0.85 m	1.45 m x 0.85 m	1.45 m x 0.85 m

Installation instructions



The edge insulation strip must be fixed to the walls.



The panels must be laid out and joined simply by pressing the elements into each other. The insulation requirements of EN 4108 and the Energy Saving Ordinance (EnEV) must be observed in any event.



The pipe positioning panels must be sealed with PE sealing tape at the edges.



The heating pipe is simply pressed into the pipe positioning plates.



The pipes are finally connected to the manifold.



Installation completed with the pipe positioning plate system with pipes laid in a bifilar pattern.

3.7 Wall heating system

The MAINCOR wall heating system for wet and dry construction is used when underfloor heating cannot be installed or an additional heat source is required. The MAINCOR wall heating system offers considerable advantages compared to conventional heating systems with respect to low flow temperatures. Walls must be structurally capable of supporting the wall heating. Angular and flatness tolerances according to DIN 18202 must be observed.

Areas of application

Heating and cooling of buildings with low flow temperatures.
Dry or classical construction.



System components

Product designation	Clip rail	Dry construction aluminium VA 12.5
Code	50.903.036	51.903.030
Colour	black	white / aluminium
Material	PP	EPS / Alu
Width	45 mm	0,5 m
Length	1 m	1 m
Packaging unit	100 pcs	10 pcs

Possible pipes	MLCP 16 x 2.0	PE-RT 16 x 2.0	MLCP 16 x 2.0
Colour	red	white	red
Max. temperature (Pipe)	90°C	90°C	90°C
Max. operating temperature (Pipe)	70°C	70°C	70°C
Max. operating pressure at 70°C	6 bar	6 bar	6 bar
Application class (ISO 10508)	Class 4	Class 4	Class 4
Water content	0.133 l/m	0.133 l/m	0.133 l/m
PU	300 and 500 m	300 and 500 m	300 and 500 m

Planning

Surface temperatures:

∅Ceiling < 35°C

∅Wall < 35°C

Operating temperatures:

∅Flow, Ceiling 16 - 40°C

∅Flow, Wall 16 - 50°C

Generally a flow temperature of 15 - 16°C should not be undercut within a cooling system to minimise the risk of condensation. The wall must be even as well as stable. Angle and evenness tolerances have to be in accordance with DIN 18202. The insulation requirements after EnEV2016 and EN1264 are applicable. The wall heating is allowed to be installed in non-bearing walls, separating walls in accordance with DIN 4102-4 and DIN 18183.

Installation

In the area of building joints the wall heating must be interrupted. Pipes must not cross joints! Horizontal maender installation is the choice. Consider the maximum of 4 m width of the heating area and 2 m in height. When using rail clips a maximum gap between the rails of 500 m on walls and 333 mm on ceilings must be respected. When installing the wall system with the dry installation plates the plates must be fixed with Mapei Ultrabond adhesive.

Max. Flow temperature:

Plaster board: <= 45°C

Gypsum fiber board: <= 50°C

Subsequent works

The pressure test is to be performed after the technical manual MAINFLOOR. Functional heating: Fundamentally a functional test has to be performed. Always the requirements of the plaster manufacturers are binding. A good practice is that the functionally heating at cement plaster starts the earliest 21 days after plastering. When using gypsum plaster or clay plaster the functional heating can start after 7 days after plastering.

The plaster base shall be

- sufficiently rigid,
- not water proof, homogenous, similar absorbent,
- rough, dry, dirt free, dust free,
- free of bleedings,
- frost-free and it must be >5°C.

Normally plaster plates or gypsum fiber plates are being used for panelling in accordance with DIN 18181. Those plates are normally 12.5 mm thick. When plastering or joint sealing the manufacturers requirements are binding! The approved practices have to be met as well as the static and weight bearing of the wall for mounting a wall heating.

For wall heating systems plaster with bonding agents of gypsum, gypsum/chalk, chalk/cement, cement, clay or bonding agents according to DIN 18550 are suitable. The necessity of plaster reinforcement is depending of the plaster system. Plaster reinforcements are inserts like mineral fiber, plastic fibre, glas fibre mesh, wich are minimizing the cracking of the plaster.

Suitable plaster	Chalk-Gypsum-Plaster	Chalk-Cement-Plaster
Manufacturer	Knauf MP 75F or MP 75 G/F	MARMORIT Rotkalk or MARMORIT biorit 110
Max. Flow temperature	50°C*	50°C*
Thermal conductivity	0.58 W/mK	0.75 - 0.87 W/mk

* Manufacturers guidelines have to be met

Applicable norms for planning/installation of wall or ceiling heating systems

- ENEC
- DIN 1186 Gypsums
- DIN EN 1264 Floor heating systems
- DIN 41002 Fire protection in building construction
- DIN 4108 Thermal insulation in building construction
- DIN 4109 Noise cancelling in building construction
- DIN 4726 Warm water surface heating systems
- DIN 18180 Gypsum plates
- DIN 18181 Gypsum plates in building construction
- DIN 18182 Accosiores for processing gypsum plates
- DIN 18195 Sealing of buildings
- DIN Dimensional tolerances in building construction
- DIN 18350 Plaster and stucco works
- DIN EN 18557 Mortar
- DIN EN 13162-13171 Insulation materials for buildings

Thermal output table

Plastered wall heating system at 5k spread according to DIN EN 1264

Average flow temperature	Room temperature	Gypsum plaster Installation gap 10 cm $\lambda=0.58$ 35 mm				Gypsum plaster Installation gap 15 cm $\lambda=0.58$ 35 mm				Gypsum plaster Installation gap 20 cm $\lambda=0.58$ 35 mm				Chalk-Cement Installation gap 10 cm $\lambda=0.75$ 35 mm				Chalk-Cement Installation gap 15 cm $\lambda=0.75$ 35 mm				Chalk-Cement Installation gap 20 cm $\lambda=0.75$ 35 mm			
θ_m	θ_r	RZ	θ_F	AZ	θ_F	RZ	θ_F	AZ	θ_F	RZ	θ_F	AZ	θ_F	RZ	θ_F	AZ	θ_F	RZ	θ_F	AZ	θ_F	RZ	θ_F	AZ	θ_F
°C	°C	W / m ²	°C	W / m ²	°C	W / m ²	°C	W / m ²	°C	W / m ²	°C	W / m ²	°C	W / m ²	°C	W / m ²	°C	W / m ²	°C	W / m ²	°C	W / m ²	°C	W / m ²	°C
30	15	60.6	22.6	55,0	21,9	47,0	20,9	67,6	23,5	61,4	22,7	52,5	21,6	67,6	23,5	61,4	22,7	52,5	21,6	67,6	23,5	61,4	22,7	52,5	21,6
30	18	48.2	24.0	43,8	23,5	37,4	22,7	53,8	24,7	48,8	24,1	41,7	23,2	53,8	24,7	48,8	24,1	41,7	23,2	53,8	24,7	48,8	24,1	41,7	23,2
30	20	39.9	25.0	36,2	24,5	30,9	23,9	44,5	25,6	40,4	25,1	34,6	24,3	44,5	25,6	40,4	25,1	34,6	24,3	44,5	25,6	40,4	25,1	34,6	24,3
30	22	31.5	25,9	28,6	25,6	24,4	25,1	35,2	26,4	31,9	26,0	27,3	25,4	35,2	26,4	31,9	26,0	27,3	25,4	35,2	26,4	31,9	26,0	27,3	25,4
30	24	23.0	26,9	20,8	26,6	17,8	26,2	25,6	27,2	23,3	26,9	19,9	26,5	25,6	27,2	23,3	26,9	19,9	26,5	25,6	27,2	23,3	26,9	19,9	26,5
35	15	81.2	25,1	73,6	24,2	62,9	22,9	90,5	26,3	82,2	25,3	70,2	23,8	90,5	26,3	82,2	25,3	70,2	23,8	90,5	26,3	82,2	25,3	70,2	23,8
35	18	68.9	26,6	62,4	25,8	53,3	24,7	76,8	27,6	69,7	26,7	59,6	25,4	76,8	27,6	69,7	26,7	59,6	25,4	76,8	27,6	69,7	26,7	59,6	25,4
35	20	60.6	27,6	55,0	26,9	47,0	25,9	67,6	28,5	61,4	27,7	52,5	26,6	67,6	28,5	61,4	27,7	52,5	26,6	67,6	28,5	61,4	27,7	52,5	26,6
35	22	52.4	28,5	47,5	27,9	40,6	27,1	58,4	29,3	53,0	28,6	45,3	27,7	58,4	29,3	53,0	28,6	45,3	27,7	58,4	29,3	53,0	28,6	45,3	27,7
35	24	44.1	29,5	40,0	29,0	34,2	28,3	49,2	30,1	44,6	29,6	38,2	28,8	49,2	30,1	44,6	29,6	38,2	28,8	49,2	30,1	44,6	29,6	38,2	28,8
40	15	101.7	27,7	92,2	26,5	78,7	24,8	113,4	29,2	102,9	27,9	88,0	26,0	113,4	29,2	102,9	27,9	88,0	26,0	113,4	29,2	102,9	27,9	88,0	26,0
40	18	89.4	29,2	81,0	28,1	69,2	26,7	99,7	30,5	90,5	29,3	77,3	27,7	99,7	30,5	90,5	29,3	77,3	27,7	99,7	30,5	90,5	29,3	77,3	27,7
40	20	81.2	30,1	73,6	29,2	62,9	27,9	90,5	31,3	82,2	30,3	70,2	28,8	90,5	31,3	82,2	30,3	70,2	28,8	90,5	31,3	82,2	30,3	70,2	28,8
40	22	73.0	31,1	66,2	30,3	56,5	29,1	81,4	32,2	73,9	31,2	63,1	29,9	81,4	32,2	73,9	31,2	63,1	29,9	81,4	32,2	73,9	31,2	63,1	29,9
40	24	64.7	32,1	58,7	31,3	50,1	30,3	72,2	33,0	65,5	32,2	56,0	31,0	72,2	33,0	65,5	32,2	56,0	31,0	72,2	33,0	65,5	32,2	56,0	31,0
45	15	122.1	30,3	110,7	28,8	94,6	26,8	136,2	32,0	123,6	30,5	105,7	28,2	136,2	32,0	123,6	30,5	105,7	28,2	136,2	32,0	123,6	30,5	105,7	28,2
45	18	109.8	31,7	99,6	30,5	85,1	28,6	122,5	33,3	111,2	31,9	95,0	29,9	122,5	33,3	111,2	31,9	95,0	29,9	122,5	33,3	111,2	31,9	95,0	29,9
45	20	101.7	32,7	92,2	31,5	78,7	29,8	113,4	34,2	102,9	32,9	88,0	31,0	113,4	34,2	102,9	32,9	88,0	31,0	113,4	34,2	102,9	32,9	88,0	31,0
45	22	93.5	33,7	84,8	32,6	72,4	31,0	104,2	35,0	94,6	33,8	80,9	32,1	104,2	35,0	94,6	33,8	80,9	32,1	104,2	35,0	94,6	33,8	80,9	32,1
45	24	85.3	34,7	77,3	33,7	66,0	32,3	95,1	35,9	86,3	34,8	73,8	33,2	95,1	35,9	86,3	34,8	73,8	33,2	95,1	35,9	86,3	34,8	73,8	33,2
50	15	142.6	32,8	129,3	31,2	110,4	28,8	159,0	34,9	144,3	33,0	123,3	30,4	159,0	34,9	144,3	33,0	123,3	30,4	159,0	34,9	144,3	33,0	123,3	30,4
50	18	130.3	34,3	118,2	32,8	100,9	30,6	145,3	36,2	131,9	34,5	112,7	32,1	145,3	36,2	131,9	34,5	112,7	32,1	145,3	36,2	131,9	34,5	112,7	32,1
50	20	122.1	35,3	110,7	33,8	94,6	31,8	136,2	37,0	123,6	35,5	105,7	33,2	136,2	37,0	123,6	35,5	105,7	33,2	136,2	37,0	123,6	35,5	105,7	33,2
50	22	113.9	36,2	103,3	34,9	88,2	33,0	127,1	37,9	115,3	36,4	98,6	34,3	127,1	37,9	115,3	36,4	98,6	34,3	127,1	37,9	115,3	36,4	98,6	34,3
50	24	105.8	37,2	95,9	36,0	81,9	34,2	117,9	38,7	107,0	37,4	91,5	35,4	117,9	38,7	107,0	37,4	91,5	35,4	117,9	38,7	107,0	37,4	91,5	35,4
55	15	163.0	35,4	147,8	33,5	126,2	30,8	181,8	37,7	165,0	35,6	141,0	32,6	181,8	37,7	165,0	35,6	141,0	32,6	181,8	37,7	165,0	35,6	141,0	32,6
55	18	150.7	36,8	136,7	35,1	116,7	32,6	168,1	39,0	152,6	37,1	130,4	34,3	168,1	39,0	152,6	37,1	130,4	34,3	168,1	39,0	152,6	37,1	130,4	34,3
55	20	142.6	37,8	129,3	36,2	110,4	33,8	159,0	39,9	144,3	38,0	123,3	35,4	159,0	39,9	144,3	38,0	123,3	35,4	159,0	39,9	144,3	38,0	123,3	35,4
55	22	134.4	38,8	121,9	37,2	104,1	35,0	149,9	40,7	136,0	39,0	116,3	36,5	149,9	40,7	136,0	39,0	116,3	36,5	149,9	40,7	136,0	39,0	116,3	36,5
55	24	126.2	39,8	114,5	38,3	97,7	36,2	140,7	41,6	127,8	40,4	109,2	37,6	140,7	41,6	127,8	40,4	109,2	37,6	140,7	41,6	127,8	40,4	109,2	37,6
60	15	183.4	37,9	166,3	35,8	142,1	32,8	204,5	40,6	185,7	38,2	158,7	34,8	204,5	40,6	185,7	38,2	158,7	34,8	204,5	40,6	185,7	38,2	158,7	34,8
60	18	171.2	39,4	155,2	37,4	132,6	34,6	190,9	41,9	173,3	39,7	148,1	36,5	190,9	41,9	173,3	39,7	148,1	36,5	190,9	41,9	173,3	39,7	148,1	36,5
60	20	163.0	40,4	147,8	38,5	126,2	35,8	181,8	42,7	165,0	40,6	141,0	37,6	181,8	42,7	165,0	40,6	141,0	37,6	181,8	42,7	165,0	40,6	141,0	37,6
60	22	154.8	41,4	140,4	39,5	119,9	37,0	172,7	43,6	156,7	41,6	133,9	38,7	172,7	43,6	156,7	41,6	133,9	38,7	172,7	43,6	156,7	41,6	133,9	38,7
60	24	146.6	42,3	133,0	40,6	113,6	38,2	163,5	44,4	148,4	42,6	126,9	39,9	163,5	44,4	148,4	42,6	126,9	39,9	163,5	44,4	148,4	42,6	126,9	39,9



Recommended surface temperature for wall heating systems $\leq 35^\circ\text{C}$.

Installation instructions



If required: fixing insulation. The heat demand must be determined beforehand depending on the heating load according to DIN EN 12831. As no standards exist for wall heating systems with regard to testing, design, layout and construction, thermal design/planning takes place according to DIN EN 1264.



The dry construction element Alu VA 12.5 is fixed to the wall using Mapei Ultrabond adhesive.



After installation of the dry construction elements, the pipes are laid ascending in a meander pattern and pressed into the groove. The flow pipe must be mounted so that the water flows from the bottom up along the wall.



Semi-finished laid wall heating prior to plastering.

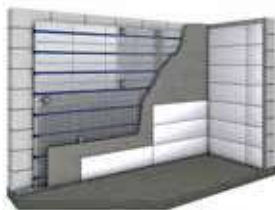

Mesh must be placed over the installed wall heating to support the plaster. Important to note is that pure gypsum plaster cannot be used at temperatures above 50°C.



The laid pipes are connected to the manifold.

Wall heating drywall constructions / Alu

Wall heating in drywall constructions with counter battens

- 1 Raw ceiling
- 2 Dry construction system + MFL system pipe 30 mm
- 3 Counter battens (30 mm)
- 4 Drywall panel 12.5 mm
- 5 Fastening and screw
- 6 Wall covering (coating, wallpaper, tiles)

42.5 mm

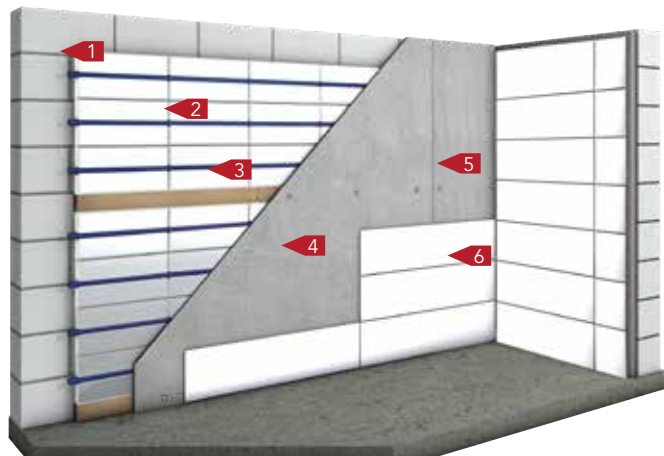

 $\geq 0.80 \text{ W / m}^2\text{K}$

 $\sim 20 \text{ kg / m}^2$

Deadweight System including counter battens, pipe and drywall panel

Gypsum fiberboard, e.g. Fermacell	Gypsum board, e.g. Rigips		
Living area 12.5 mm expansion panel	Living area 12.5 mm Rigips construction panel RB	Feuchträume (bathroom) 12.5 mm Rigips construction panel RBI	Living area 10 mm Climafit Prothermo
$\lambda_{tr} = 0.28 \text{ W / m}^2\text{K}$	$\lambda_{tr} = 0.25 \text{ W / m}^2\text{K}$	$\lambda_{tr} = 0.25 \text{ W / m}^2\text{K}$	$\lambda_{tr} = 0.52 \text{ W / m}^2\text{K}$

 System elements are fixed with e. g. MAPEI Ultrabond Ecofix / non-oppressive assembly foam (PU foam) or tacked to the counter battens

 If the wall heating elements are installed on exterior walls, the dew point is to be controlled. If necessary, add a vapour barrier between wall heating elements and drywall panel

 Screw Fermacell drywall panel every 25 cm with 30 x 3.9 mm fermacell screws on the counter battens; mount and fix panels butt jointed

 Screw Rigips drywall panel (RB / RBI) every 25 cm with Ripigs rapid fastening screws TN 30 x 3.8 mm; Climafit with Climafit rapid fastening screws TBGOLD 9.5 x 23 mm to the counter battens; install panels with 6 – 7 mm joint width and fill in with Rigips Vario joint filler

Note detailed information in the processing guidelines of the manufacturer

 Max. flow temperature with drywall panels: 50°C

Thermal output

Wall heating drywall constructions / Alu

Gypsum fiber element, Gypsum plaster, Lime-cement

Nominal layer thickness 12.5 mm	Nominal layer thickness 15 mm	Nominal layer thickness 15 mm
Thermal conductivity λ 0.28 W / mK	Thermal conductivity λ 0.58 W / mK	Thermal conductivity λ 0.75 W / mK
Spread σ 5 K	Spread σ 5 K	Spread σ 5 K

Average heating water temperature	Room temperature	Belag $R_{\lambda,B} = 0.0 \text{ m}^2 \text{ K} / \text{W}$ Gypsum fiberboard 12.5 mm*				Belag $R_{\lambda,B} = 0.0 \text{ m}^2 \text{ K} / \text{W}$ Gypsum plaster 15 mm				Belag $R_{\lambda,B} = 0.0 \text{ m}^2 \text{ K} / \text{W}$ Lime-cement 15 mm			
		VA = 125 mm		VA = 250 mm		VA = 125 mm		VA = 250 mm		VA = 125 mm		VA = 250 mm	
		RZ	θ_F	AZ	θ_F	RZ	θ_F	AZ	θ_F	RZ	θ_F	AZ	θ_F
θ_m	θ_i	W / m ²	°C	W / m ²	°C	W / m ²	°C	W / m ²	°C	W / m ²	°C	W / m ²	°C
30	15	71,7	24,0	56,7	22,1	80,9	25,1	63,7	23,0	84,3	25,5	66,4	23,3
30	18	57,1	25,1	45,1	23,6	64,4	26,0	50,7	24,3	67,1	26,4	52,8	24,6
30	20	47,2	25,9	37,3	24,7	53,3	26,7	42,0	25,2	55,5	26,9	43,7	25,5
30	22	37,3	26,7	29,5	25,7	42,1	27,3	33,2	26,1	43,9	27,5	34,5	26,3
30	24	27,2	27,4	21,5	26,7	30,7	27,8	24,2	27,0	32,0	28,0	25,2	27,1
35	15	96,0	27,0	75,9	24,5	108,3	28,5	85,3	25,7	112,8	29,1	88,9	26,1
35	18	81,5	28,2	64,4	26,0	91,9	29,5	72,4	27,0	95,7	30,0	75,4	27,4
35	20	71,7	29,0	56,7	27,1	80,9	30,1	63,7	28,0	84,3	30,5	66,4	28,3
35	22	62,0	29,7	49,0	28,1	69,9	30,7	55,1	28,9	72,8	31,1	57,3	29,2
35	24	52,2	30,5	41,2	29,2	58,8	31,4	46,4	29,8	61,3	31,7	48,3	30,0
40	15	120,3	30,0	95,1	26,9	135,6	32,0	106,9	28,4	141,3	32,7	111,3	28,9
40	18	105,7	31,2	83,6	28,4	119,2	32,9	94,0	29,7	124,2	33,5	97,8	30,2
40	20	96,0	32,0	75,9	29,5	108,3	33,5	85,3	30,7	112,8	34,1	88,9	31,1
40	22	86,3	32,8	68,2	30,5	97,3	34,2	76,7	31,6	101,4	34,7	79,9	32,0
40	24	76,6	33,6	60,6	31,6	86,4	34,8	68,1	32,5	90,0	35,3	70,9	32,9
45	15	144,5	33,1	114,2	29,3	162,9	35,4	128,4	31,0	169,8	36,2	133,7	31,7
45	18	130,0	34,2	102,7	30,8	146,5	36,3	115,5	32,4	152,7	37,1	120,2	33,0
45	20	120,3	35,0	95,1	31,9	135,6	37,0	106,9	33,4	141,3	37,7	111,3	33,9
45	22	110,6	35,8	87,4	32,9	124,7	37,6	98,3	34,3	129,9	38,2	102,3	34,8
45	24	100,9	36,6	79,7	34,0	113,8	38,2	89,7	35,2	118,5	38,8	93,3	35,7
50	15	168,7	36,1	133,3	31,7	190,2	38,8	149,9	33,7	198,2	39,8	156,1	34,5
50	18	154,1	37,3	121,9	33,2	173,8	39,7	137,0	35,1	181,1	40,6	142,6	35,8
50	20	144,5	38,1	114,2	34,3	162,9	40,4	128,4	36,0	169,8	41,2	133,7	36,7
50	22	134,8	38,8	106,6	35,3	152,0	41,0	119,8	37,0	158,4	41,8	124,7	37,6
50	24	125,1	39,6	98,9	36,4	141,1	41,6	111,2	37,9	147,0	42,4	115,8	38,5
55	15	192,8	39,1	152,4	34,1	217,4	42,2	171,4	36,4	226,6	43,3	178,4	37,3
55	18	178,3	40,3	141,0	35,6	201,1	43,1	158,5	37,8	209,5	44,2	165,0	38,6
55	20	168,7	41,1	133,3	36,7	190,2	43,8	149,9	38,7	198,2	44,8	156,1	39,5
55	22	159,0	41,9	125,7	37,7	179,3	44,4	141,3	39,7	186,8	45,4	147,1	40,4
55	24	149,3	42,7	118,0	38,8	168,4	45,0	132,7	40,6	175,4	45,9	138,2	41,3



Thermal output on the basis of DIN EN 1264



Recommended Maximum surface temperatures wall $\leq 40^\circ\text{C}$

* In constructions with counter battens (K8020, K8520), the area fraction of the counter battens is subtracted from the heated wall surface

4. Control system

4.1 Basic principles

A modern heating system is made up of numerous individual components. A sophisticated control system is an important building block. MAINCOR control systems are perfectly matched for quick and easy installation and are of the highest quality.

Principle layout

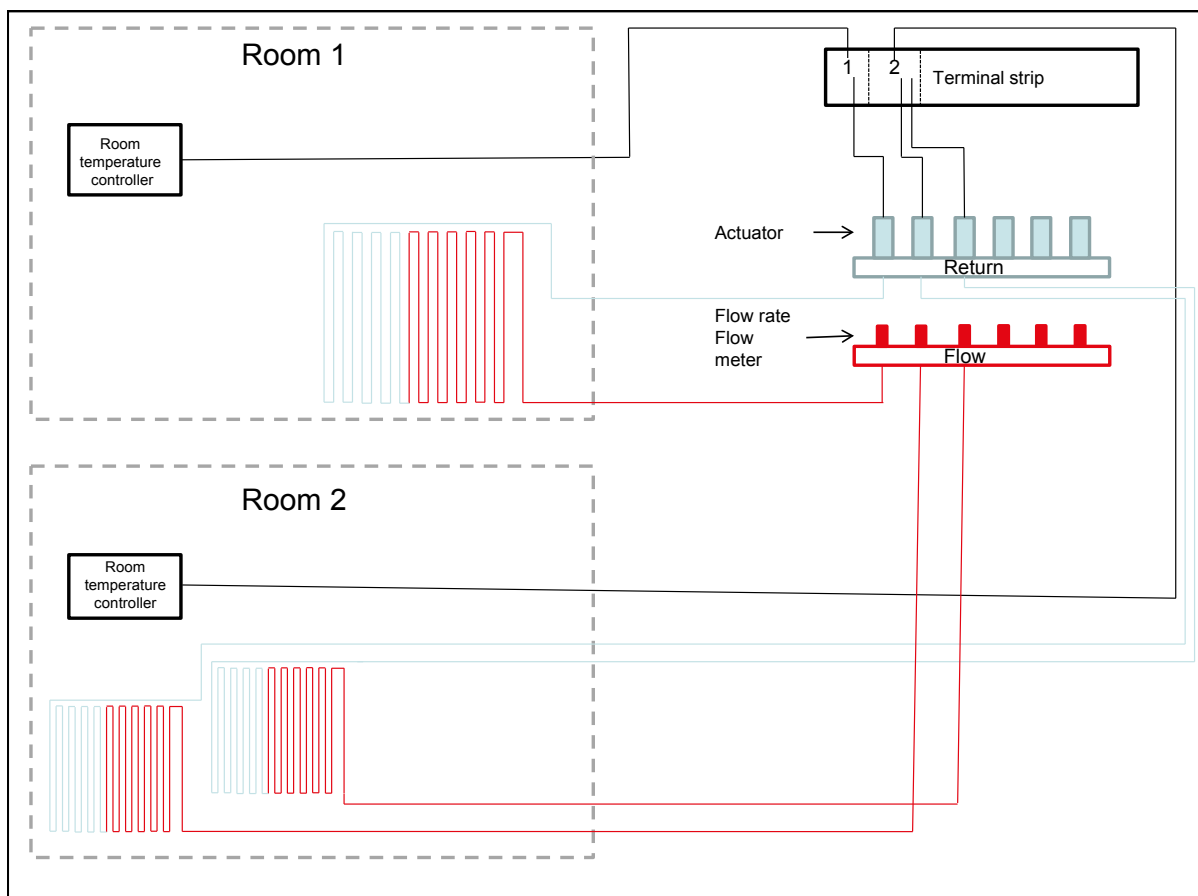

The current room temperature is measured by the thermostat, which heats the room based on the preset temperature. The thermostat is connected to the actuator via a terminal strip. When the thermostat sends a „heat“ signal, the actuator is opened and heats the heating circuit(s). Each terminal strip channel can control several actuators (heating circuits).

The connection between the thermostat and terminal strip can be wired or radio controlled. The principle shown above applies to both systems.

Connection of the thermostat must take place by a trained and qualified person.

4.2 Control technology 4.0 leaflet

Wired



Room thermostat Analogical

Via a signal onto the switch over contact the analogical thermostats logic is switched. When in cooling mode the set temperature is exceeded the output for the actuator will be switched on.

All analogical thermostats do have an input contact which will trigger a temperature increment of 2k.



Digital - with display

Within the standard model the nominal temperature will be set and the room temperature will be permanently shown in the display. A symbol indicates the status of the actuator output. A variety of comfort functions (day, night, holiday min. max and so forth) can be set. Further on the standard variant is having an input contact which will trigger a temperature increment of 2k.

The Control variant of the thermostat is having additionally an integrated timer which is freely programmable. It can switch between night and day mode. Via an output this signal can be forwarded to additional thermostats which then copy the mode. The temperature increment can be set.



When using the Control variant of the thermostat the heating and cooling mode can be set via an external input signal.

An external temperature sensor can be connected to the Control variant of the thermostat!

The connection between the thermostats and the terminal strip can be realised with a cable (0.22 qmm - 1.5 qmm). The amount of wires depends on the application:

regular

- 2 x Voltage supply: N and L
- 1 x Signal

optional

- 1x Temperature increment
- 1x Switch over Heating/Cooling



Terminal strip

The grid connection cable must be ordered separately (Europlug).

If a pump control or switch over between heating and cooling is needed, the StandardPlus variant has to be chosen. Also the connection of external sensors (temperature limiter, hygrometer) is only possible with the StandardPlus variant.

Both variants do have an input for temperature step down. Also there is the possibility to have a signal from a time clock or from the room thermostat Control which can choose the step down mode.

The terminal strip StandardPlus is existing as a 24V and 230V variant; the standard terminal strip can be set to 24V or 230V by choosing the correct fuse.

The variant with 6 zones / 230V can steer up to 15 MAINCOR actuators, the variant with 10 zones / 230V can steer up to 18 MAINCOR actuators. If the 24V variants are used the maximum power all actuators must not exceed 24W.

4.3 Actuator

4.3.1 Actuator 4.0



Similar illustration!

The advantages at one glance:

- Compact size, small dimensions
- All around function indicator
- First open function
- Maintenance-free
- Noiseless
- High functional safety and long expected service life
- High over-voltage protection
- Low power consumption
- Snap-on installation
- Valve-adapter concept
- Adaptation check on valve

Characteristics

Typ 230 V

Code	50.903.011
Version	normally closed
Voltage	230 V AC, + 10%...-10%, 50/60 Hz
Max. inrush current	300 mA for max. 200 ms
Operating current	8 mA
Operating power	2 W
Closing and opening times	approx. 3 min.
Actuator travel	4 mm
Actuating force	100 N ± 5%
Fluid temperature	0 to 100 °C
Storage temperature	-25 to +60 °C
Ambient temperature	0 to +60 °C
Degree/class of protection	IP54 ¹⁾ / II
CE conformity according to	EN 60730
Housing / housing colour	PA / grey
Weight	100 g with 1 m connection cable
Connecting cable / length	2 x 0,75 mm ² PVC, grey / 1 m
Overvoltage protection according to EN 60730-1	2.5 kV

Typ 24 V

Code	50.903.111
Version	normally closed
Voltage	24 V AC/DC, 0-60 Hz, -10%...+20%
Max. inrush current	250 mA for max. 2min.
Operating current	75 mA
Operating power	2 W
Closing and opening times	approx. 3 min.
Actuator travel	4 mm
Actuating force	100 N ± 5%
Fluid temperature	0 to +100 °C
Storage temperature	-25 to +60 °C
Ambient temperature	0 to +60 °C
Degree/class of protection	IP54 ¹⁾ / III
CE conformity according to	EN 60730
Housing / housing colour	PA / grey
Weight	100g with 1 m connection cable
Connecting cable / length	2 x 0.75 mm ² PVC, grey / 1 m

¹⁾ in all installation positions

General Information

The Actuator is a thermoelectric valve drive for opening and closing valves on heating circuit distributors of concealed floor heating and cooling systems. Features, as a compact and modern casing, versions in normally closed and normally open, valve adapter concept and an enhanced life time have been of particular importance. This allows to fulfill the requirements within the bounds of technical reliability, improved installation and a nearby noiseless operation.

The valve drive mechanism of the Actuator uses a PTC resistor heated elastic element and a compression spring. The wax element is heated by applying the operating voltage and moves the integrated ram. The force generated by the movement is transferred on the valve lifter and thus opens and closes the valve.

Function Display

The function display of the Actuator (all-round display) allows identifying the operating condition at a glance.

Normally Closed (valve closed)

The valve is opened steadily by the ram motion upon switching on the operating voltage and after expiry of the dead time. The elastic element cools down after the operating voltage is cut and after expiry of the hold time, the valve is closed evenly by the closing force of the compression spring. The closing force of the compression spring is matched to the closing force of commercially available valves and keeps the valve normally closed.

First-Open Function

In its delivery condition, the Actuator is normally open due to the First-Open function. This enables heating operation during the carcass construction phase even when the electric wiring of the single room control is not yet complete. When commissioning the system at a later date, the First-Open function is automatically unlocked by applying the operating voltage (for more than 6 minutes) and the Actuator is fully operable.

Application

The Actuator serves for optimum control of valves on heating circuit distributors. Control is done by a room thermostat with two-point output or pulse-width modulation.

Scope of Supply

- 1 x Actuator
- 1 x Installation manual
- 1 x Valve Adapter for MAINCOR manifolds (separately available Code: 50.003.044)

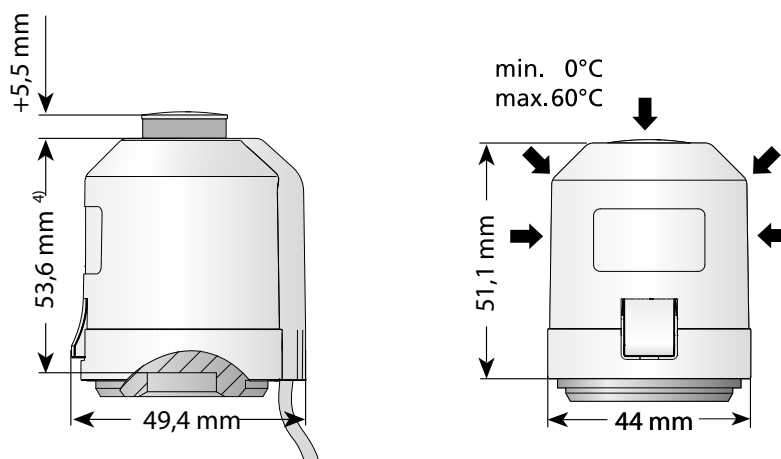

Instruction

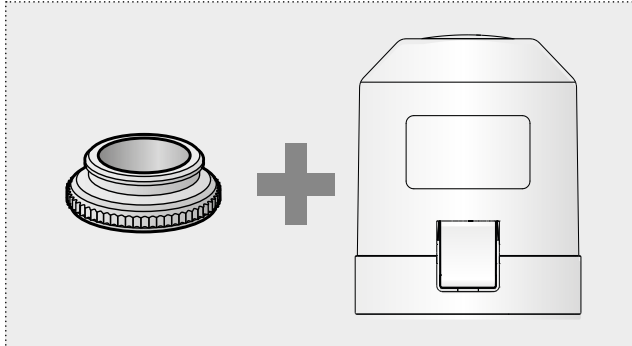

1.

The actuator will be delivered together with an adapter ring which fits to the MAINCOR manifolds.

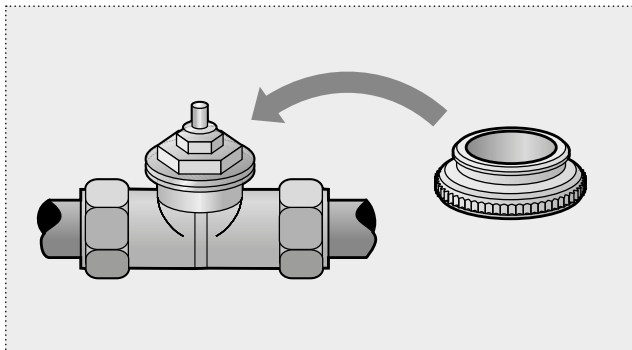

2.

The adapter ring needs to be screwed on the valve first.

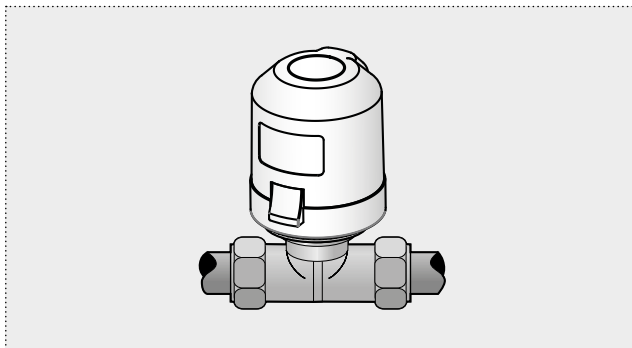

3.

The actuator is pushed onto the adapter ring. There is not particularly strong force needed. The click in mechanism indicates that the actuator sits firm.

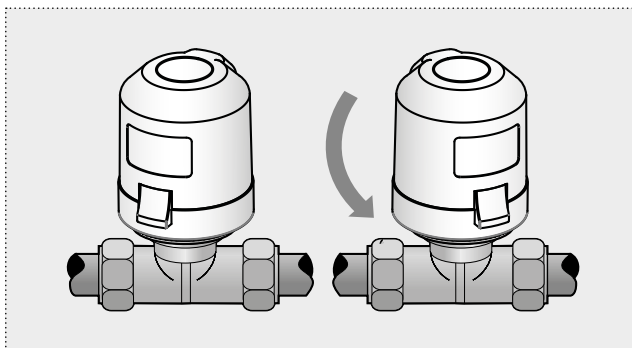

4.

When installed, the actuator can be freely rotated.

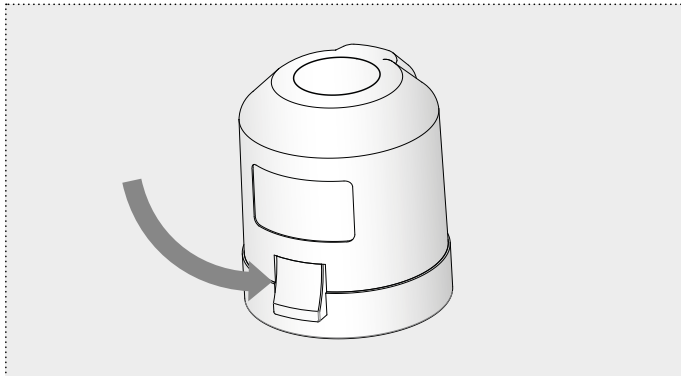

5.

Via a push on the side button the actuator will be dislocated and can be disconnected from the manifold.

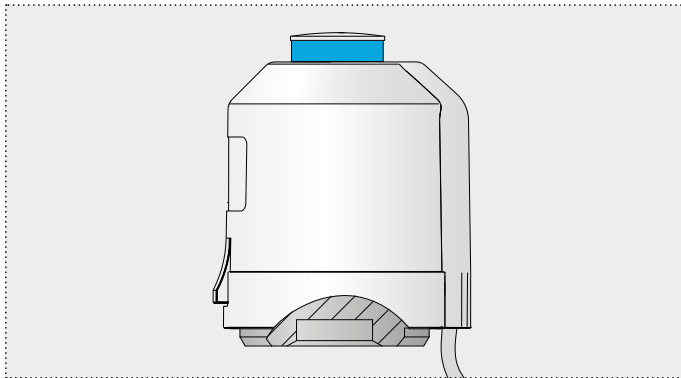

6.

The mounting/dismounting can be done also when the valve is opened. A mechanical release is not necessary. The operating mode is indicated via the coloured top cap.

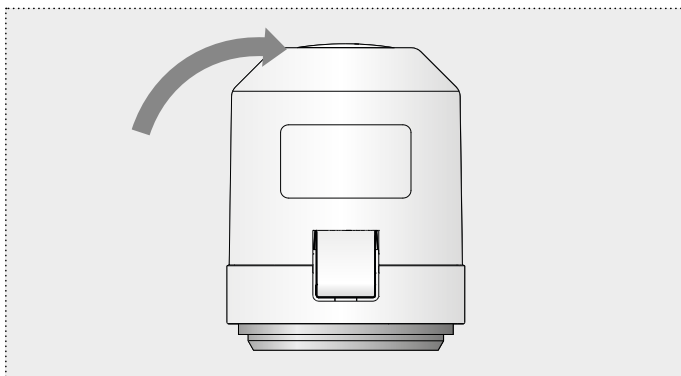

7.

The actuator is first open. That means it is delivered in open position. This allows the installer to install it without electricity while the dry heating of the screed is performed. When delivered the top cap does not show the open state, but still the actuator is open.

4.3.2 NEO Actuator



Similar illustration!

Product designation

Typ 230 V

Code	50.903.050
Option	NC = normally closed
Width	37 mm
Voltage	230 V AC, + 10%...-10%, 50/60 Hz
Switch on current	300 mA
Operating current	8 mA
Operating power	2 W
Closing / opening time	ca. 170 sec.
Connection thread	M30 x 1,5
Stroke	4 mm
Displacement force	100 N ± 5%
Temperature of fluid	0 - 100 °C
Temperature for storage	-25 till +60°C
Ambient temperature for operation	0 bis +60°C
Ball indentation test	90°C
Electrical protection class / Degree of pollution	IP X4 / II
CE conformity	EN 60730
Material of body / Body color	PE / RAL 7035
Type of cable	2 x 0.75 mm PVC, RAL 7035 / 0.8 m
Overvoltage strength	2.5 kV

General

Electro thermal actuator for energy efficient controlling of floor heating and cooling systems as well as radiator control. By means of the manual lock-system the installation onto the manifold is simplified and maintenance is made much easier. By opening the lock immediate flow could be created at any time.

Advantages

- compact design with just 37 mm for valve distance
- certified quality according to standard IEC 60730-2-14
- long lasting durability through sophisticated materials
- superior electrical protection class: IP X4
- energy-efficient: low electrical consumption
- toolless installation
- visual display of the actuator's status
- upside down installation possible

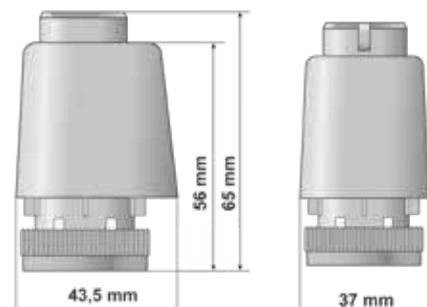

4.4 Room thermostat 4.0

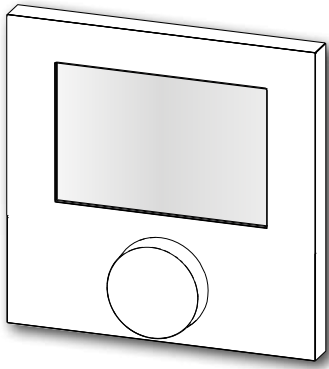

Similar illustration!

The **Room thermostat Standard** and **Control 4.0** are modern and state of the art controllers to set up the target temperature whilst measuring the actual temperature. Even with direct connected actuators an easy setup of the room temperature is possible. The setup is done by the integrated rotary knob with an as easy as it can get „push-rotary“ function. The display is language independent.

- Flat design (about 23 mm) and small dimensions (86 mm x 86 mm)
- Simple, intuitive installation and operation
- Wall mounting / mounting on flush-mounted box
- Maintenance-free
- High quality, modern design
- High functional safety
- Stand-alone or system-realizable control
- Control behavior: Two point controller
- Compliant with standards

Characteristics

Room thermostat Standard 4.0

Code

230 V

50.903.113

24 V

51.903.113

- Heating
- Normally closed
- Temperature setting range 5 ... 30°C
- Setpoint Calibration and Limitation
- Valve and antifreeze function (every 14 days for 10' ; <+ 5°)
- Fixed lowering temperature (2 K)
- Input lowering channel
- Display switching output - deactivatable
- Child safety

Room thermostat Control 4.0

Code

230 V

50.903.114

24 V

51.903.114

- Heating / Cooling
- Normally closed
- Temperature setting range 5 ... 30°C
- Setpoint Calibration and Limitation
- Valve and antifreeze function (every 14 days for 10' ; <+ 5°)
- Adjustable temperature increment
- Temperature increment input
- Monitor of switching actuator - can be deactivated
- Child safety
- Input for changeover channel heating/cooling
- Smart Start / Stop function
- Setpoint specification day and night
- Internal weekly timer
- Timer output (incremental channel)
- Cooling lock function
- Backlight



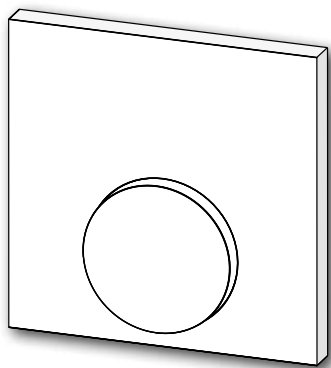

Similar illustration!

The **Room thermostat heating** and **heating / cooling** are state of the art design controllers. An easy room control is possible since the actuators can be connected directly or indirectly via a terminal strip. The setup is done via one rotary switch which is equipped with an easy to read scale.

- Flat design (about 23 mm) and small dimensions (86 mm x 86 mm)
- Simple, intuitive installation and operation
- Wall mounting / mounting on flush-mounted box
- Maintenance free
- High quality, modern design
- High functional reliability
- Stand-alone or system-realizable control
- Control behavior: Two point controller
- Compliant with standards



Characteristics:

Room thermostat heating

Code

230 V	50.903.012
24 V	51.903.012

- Heating mode
- Temperature setting range 5 ... 30°C
- Setpoint calibration (+/- 2 K)
- Frost protection function (< +6°)
- Fixed temperature increment (4 K)
- Timer input (Increment input)

Room thermostat heating/cooling

Code

230 V	50.903.016
24 V	51.903.016

- Heating/Cooling
- Temperature setting range 5 ... 30°C
- Setpoint calibration (+/- 2 K)
- Valve and antifreeze function (every 14 days for 6'; < +6°)
- Fixed incremental temperature (4 K)
- Input for changeover channel H/K
- Timer input (Increment input)
- Cooling lock function

General information about the Room Temperature Controller Standard / Control 4.0

The controller convinces with its flat construction, its simple timeless design, the generous, language-neutral display and the comfortable knob operation. Intuitively, the operating concept guides every user through the menu structure and allows a simple navigation with rotary-push mechanism. Functions as operating state and holidays can be easily accessed. The integrated weekly timer allows the programming of individual temperature profiles. This ensures the daily comfort and an energy-efficient heating / cooling mode.

Smart Start-/Smart Stop

Another highlight is the Smart Start / Smart Stop technology. It recognizes by the environmental conditions of the respective room, when must be heated to the exactly desired time to settle a feel-good temperature. Only as little energy is used as required.

General information about the room temperature controller surface-mounted

In the heating and heating / cooling versions, the room temperature controller is surface-mounted and in its functionality reduced to the max - temperature control with maximum control precision. The flat, modern Design blends harmoniously into any interior design. The setpoint temperature is set via the comfortable knob with easy-to-read scaling. Via the timer input the temperature is lowered in the absence of the user.

Heating and cooling

The main aim of the room temperature controllers heating/cooling is the temperature control of the heating and cooling systems. The switching between modes can be done automatically via the input channel H/K. If needed the cooling mode can be locked for a specific room (bath room) via a bridge between two dips. The controller is having an integrated frost prevention function for the valves.

Accessoires

- External temperature sensor (seperatly available Code 50.903.056)

Temperature sensor: NTC with 22k ohms at 25°C ± 2%
Cable length: 3 m / H03VVH2-F; 2 x 0.75 mm²
Operating temp.: 0...50°C
Degree of protection: IP 67
Max. Measuring voltage: 12 V
Isolation: designed for 230 V applications

4.5 Room thermostat flush-mounted

Room control thermostat which is suitable for common switch ranges for flush mounting. Suitable for the regulation of central heating, hydraulic floor heating, electric heating, night storage heaters etc., in conjunction with thermal actuators. Bimetallic technology with thermal feedback and high precision. Combined with the MAINCOR terminal strips standard 4.0 and Standard Plus it can be used for heating systems. A switchover (change-over) between heating and cooling is not possible.



Technical data

Code	50.903.013
Contact	1 changeover contact
Switching current	Heating 10 A (AC)
Operating voltage	AC 230 V 50/60 Hz
Output signal	heating
Control range	5 - 30°C
Hysteresis	0,5 K
Degree of protection	IP 30 (DIN EN 60529)
Dimensions	75 mm x 75 mm
Circuit diagram	

4.6 Terminal strip 4.0

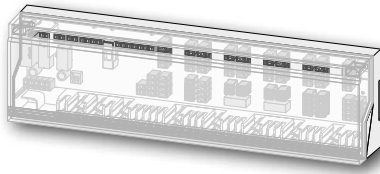

The **Terminal strip Standard** or **Standard Plus 4.0** is a high quality wired connection unit for the modern individual room control system. It serves the maximum comfort and energy-efficient use in surface temperature control for heating or heating/cooling systems. The energy supply of the system components takes place directly via the power supply. All switching commands of the controller are without delay forwarded to the connected components and actuators.

In the Standard Plus version, the terminal block has connections for switching a pump and a channel for switching heating / cooling. The connection of a temperature limiter or a dew point sensor is with the standard plus possible.

Similar illustration!

- Up to 21 connection terminals for connection for max. 18 actuators (depending on variant)
- Screwless terminal connection technology
- Proven cable routing and standard strain relief
- Clearly arranged terminals
- Simple, intuitive installation and operation
- Mounting directly on wall or DIN rail
- One housing for all variants
- High quality, modern OEM design
- High functional reliability
- Maintenance free
- Compliant with standards
- Normally closed

Characteristics



Terminal strip Standard 4.0	Code
24 V / 230 V 6-Zones	50.903.014
24 V / 230 V 10-Zones	50.903.045

- For heating only
- Temperature increment channel



Terminal strip Standard Plus 4.0	Code
230 V 6-Zones	50.903.015
230 V 10-Zones	50.903.046
24 V 6-Zones	51.903.015
24 V 10-Zones	51.903.046

- Channel for switching heating / cooling
- Incremental channel
- Input for temperature limiter / dew point sensor
- Pump control - Adjustable overrun time

General

The Terminal strip Standard / Standard Plus is the central connection unit and power supply for all components. In a clear arrangement, actuators and controllers are easy and comfortable connected with each other. The proven cable routing and standard-compliant strain relief as well as the screwless plug / clamp connection technology guarantees safe and fast wiring. The Terminal strips variants are available as 6 or 10 heating/cooling zone versions. The maximum is that up to 10 (6) room thermostats and 18 (15) actuators (21/15 connections) powered. Due to the input for the heating / cooling changeover is the standard plus control system for heating and cooling suitable. In addition, the Standard Plus has the option of an external sensor to connect.

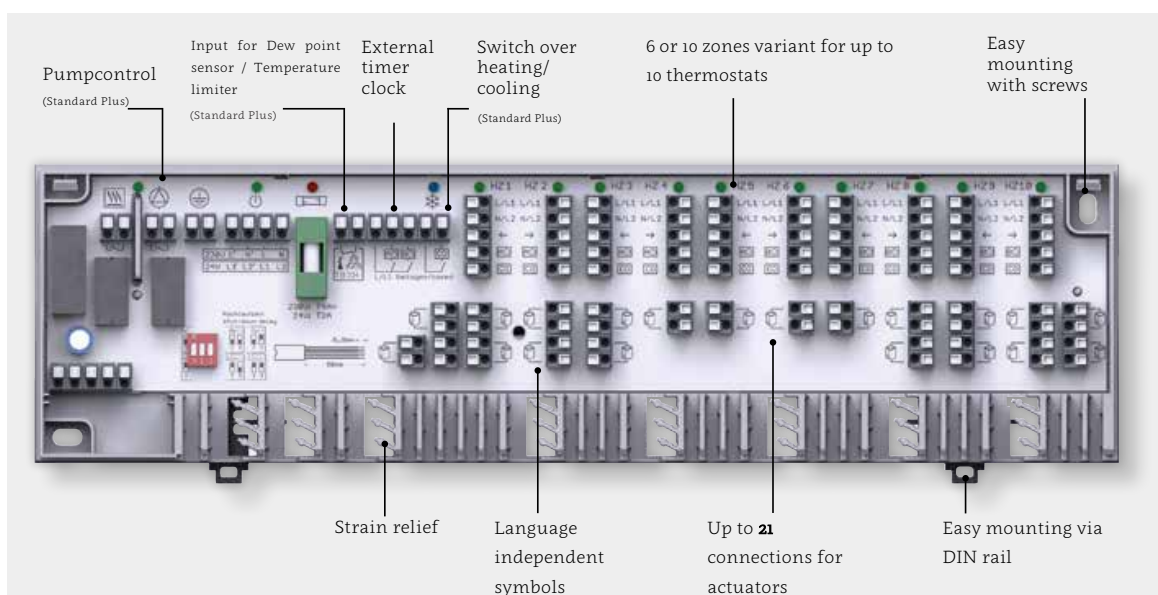

Variant Standard Plus - Illustration similar!

Accessoires

- Connection cable for terminal block 230 V (sold separately, Code 50.903.054)
- External system clock 2-channel (sold separately) Code 50.903.055)
- Safety Transformer (sold separately Code 51.903.047)

Primary: 230 V 50/60 Hz
Secondary: 24 V 30 VA
Stand by power: < 1 W

4.7 Regulation-box RTL

The control box consists of a wall mounting box with premounted RTL valve block and external RTL head, blanking plate, vent valve and wall cover. The valve block has a 3/4" external thread (eurocone) for pipe-sided connection via clamp connection. The regulation-box RTL arranged in the return flow of the heating system controls the maximum permissible return temperature in the system via an integrated RTL thermostatic valve.

Areas of application

Radiant heating
 Wall heating
 Individual room control
 Particularly for small rooms



Product data

Width	156 mm
Height	211 mm
Depth	64 mm
Depth of box with head	138 mm
Depth compensation	23 mm
Pipe connection	3/4" external thread, eurocone
Thermostat head connection	M 30 x 1.5

The adjustment range of the installed RTL thermostat head is 1-5 as shown in the temperature table below.

Regulation-box RTL adjustment range

Setting mark	1	2	3	4	5
approximate return temperature	10°C	20°C	30°C	40°C	50°C

5. Accessories

5.1 Heating manifolds

The MAINCOR stainless steel heating manifold has been designed specifically for the precise control of underfloor and wall heating systems. The return manifold is located at the top with the control valves with a M 30 x 1.5 external thread on which the MAINCOR actuators are mounted. The flow manifold is located below with either flowmeter or flow limiter.



Areas of application

Radiant heating
Wall heating
Underfloor heating

Product data

Maximum static pressure	PN 6 bar
Maximum heating medium temperature	60°C
Filling and drainage valve	1/2" External thread
Bleeder valve	manual
Heating circuit connection	3/4" eurocone

Flow manifold	NEO	
Entry - left	G 1 1/4" Internal thread	G 1" Internal thread
Exit - right	G 1" Internal thread (Fitted from the manufacturer with plugs)	G 1" Internal thread (Fitted from the manufacturer with plugs)
Flow limiter	Percentage value 0 - 100 %	-
Flowmeter	1 - 5 l/minute	1 - 5 l/minute

Return manifold	NEO	
Entry - left	G 1 1/4" Internal thread	G 1" Internal thread
Exit - right	G 1" Internal thread (Fitted from the manufacturer with plugs)	G 1" Internal thread (Fitted from the manufacturer with plugs)
Control valve connection	M 30 x 1.5 External thread	M 30 x 1.5 External thread
Maximum valve lift	3.5 mm	3.5 mm
Valve opening force	about 39 N	40 N

Heating circuits	Manifold, long Overall length in mm including ball valve	Manifold, short Overall length in mm including ball valve	NEO manifold Overall length in mm including ball valve
2	255	250	290
3	305	300	340
4	355	350	390
5	405	400	440
6	455	450	490
7	505	500	540
8	555	550	590
9	605	600	640
10	655	650	690
11	705	700	740
12	755	750	790
13	805		
14	855		
15	905		
16	955		

Accessoires for ...

Manifold stainless steel 5/4"

Ball valve 1" IG x 1 1/4" MT
Ball valve 1" IG x 1 1/4" MT edge
Ball valve 1 1/4" IG x 1 1/4" MT
Heat flow meter connection kit 1 1/4", horizontal (Code 50.903.008)
Heat flow meter connection kit 1 1/4", vertical (Code 50.903.009)
Constant control kit 1 1/4" (Code 50.903.048)

Manifold stainless steel 1" NEO

Ball valve NEO 1" IG x 1" MT
Ball valve NEO 1" IG x 1" MT edge
Ball valve 1 1/4" IG x 1 1/4" MT
Heat flow meter connection kit NEO 1", horizontal (Code 50.903.069)
Heat flow meter connection kit NEO 1", vertical (Code 50.903.068)
Constant control kit NEO 1" (Code 50.903.047)

5.2 Flow meters

The flow meter is used for precise and convenient adjustment of the required water volumes in the heating circuits. Hydronic, correctly balanced systems ensure optimal energy distribution and economical operation in accordance with the Energy Saving Ordinance. With the flow meter, any qualified person can adjust the correct water volume directly on-site without investment in training and expensive measuring instruments.



Use

The valve flow area can be varied by turning the black spindle, which simultaneously changes the flow rate. The flow cannot be shut off completely with the flow meter. If the flow needs to be shut off, this can take place with the control valve with blue cap on the return manifold. The required flow rate can be adjusted by turning the valve. For hydronic balancing, the interaction of the flow meters must be taken into account and fine adjustment made.

Product data

The flow rate is always indicated on the sight-glass of the flow meter. A Kvs value of 1.1 m³/h is reached with the flow meter fully open. The measuring accuracy is about +/- 10% of the indicated value.

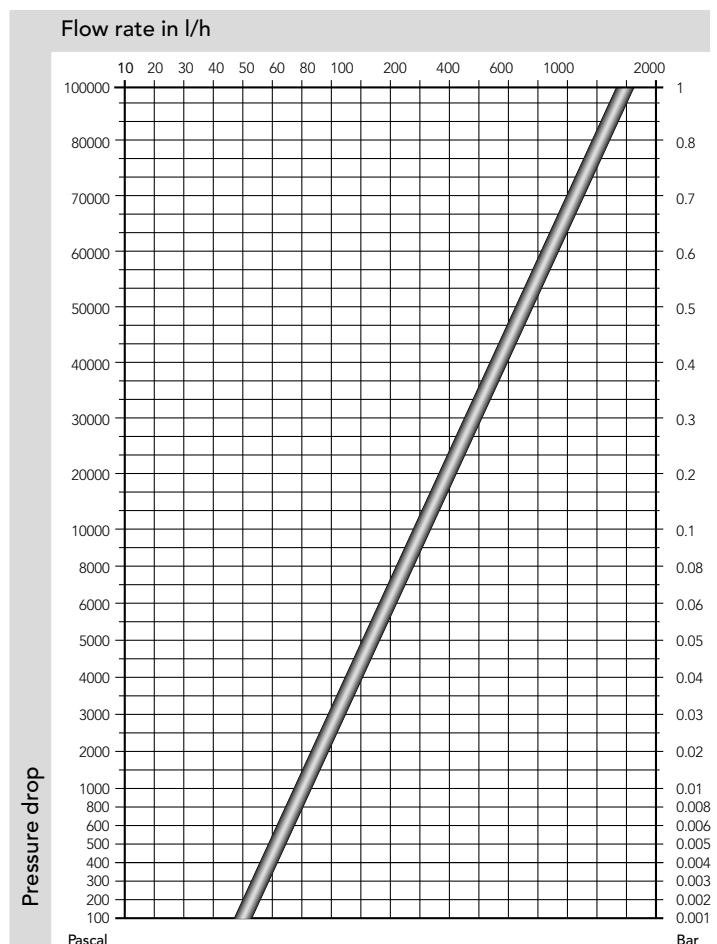

5.3 Hydronic balance with flow limiter

To ensure that heating circuits with different heat outputs or register length are only supplied with the appropriate heating water volume, hydronic balancing (inductance) of the individual heating circuits is necessary. This can take place simply and precisely with the flow limiter. For this purpose, the has a scale from 1 to 10, which corresponds to 10 to 100%. This enables more precise adjustment of Kv values from 0.025 to 0.986 m³/h.

Use

The MAINCOR flow limiter enables hydronic balancing to be carried out quickly and easily. Balancing takes place on a percentage basis in relation to the longest heating circuit, which corresponds to the setting „10“ (100%).

$(10/K) \times \text{heating circuit length} = \text{flow limiter adjustment}$
 K = longest heating circuit

Example 1		
Heating circuit	Length	Flow limiter adjustment
1	100	10
2	60	6
3	50	5
4	30	3

Example 2		
Heating circuit	Length	Flow limiter adjustment
1	60	10.00
2	20	3.33
3	45	7.50

Product data

The scale values correspond to one tenth of the respective flow percentage values. Adjustments must take place according to the table below. The diagram on the following page shows the flow rates of individual settings.

	10%	20%	30%	40%	50%	60%	70%	80%	90%	100%
Adjustment value	1	2	3	4	5	6	7	8	9	10

Flow rate diagram

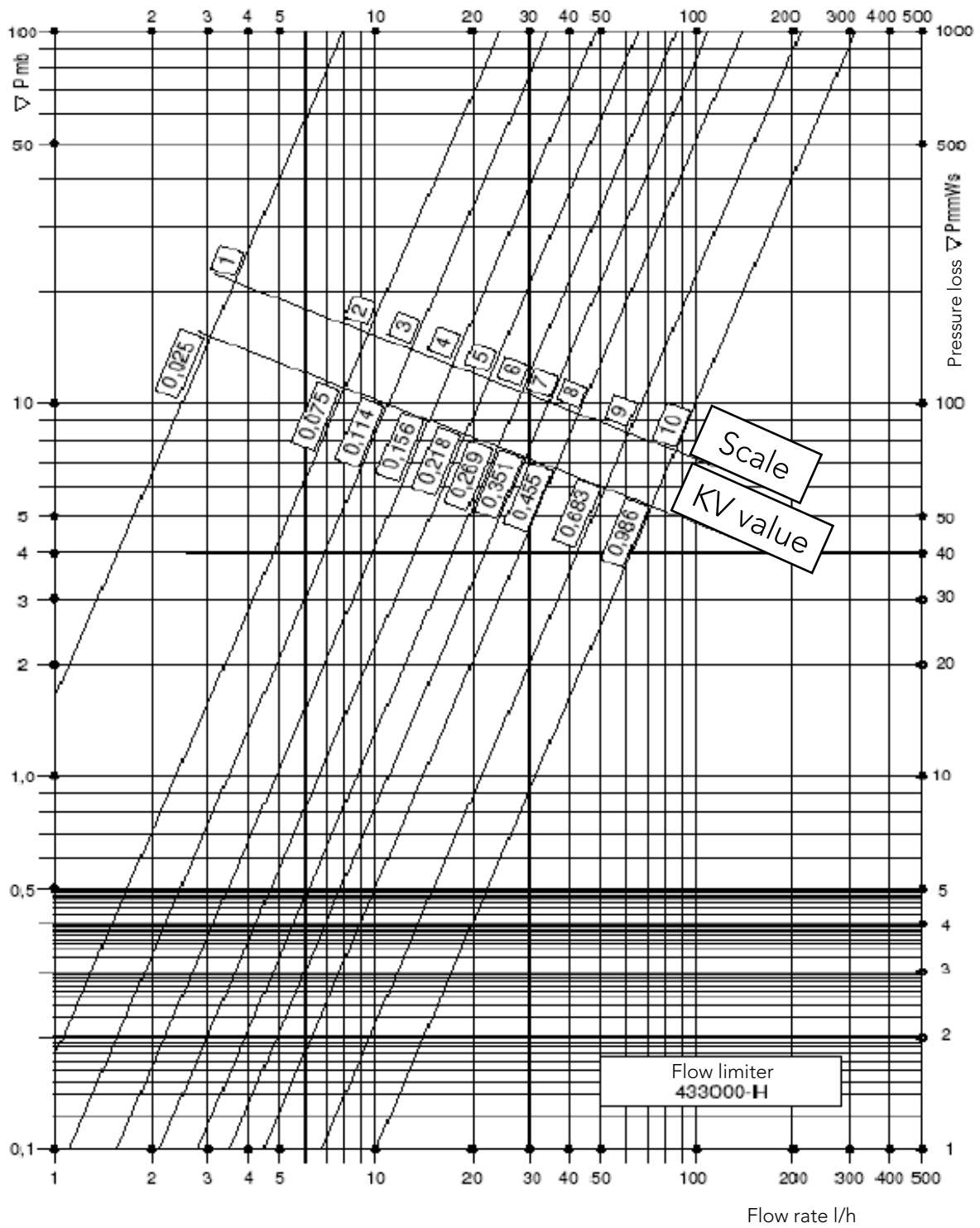

5.4 Constant control kit

Assembly and adjustment instructions

The MAINFLOOR constant control kit is for low-temperature surface heating circuits designed and it is intended to control the system temperature whereas the heat source (boiler) of 60 - 90°C should be stepped down to 30 - 50°C or limited. It is important to ensure that when using a constant control kit the distribution box by one Level must be bigger. The control station is for a maximum transferable power of up to 10 kW ($\Delta t 10K$) or a maximum flow rate of 1.3 m³ / h (maximum floor heating surface 150 m²).

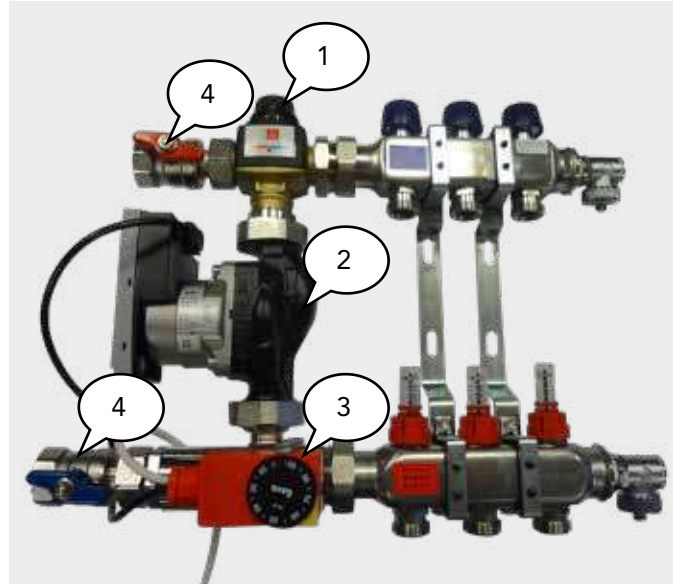

- The mixing machine (1) is a proportional controller and works without auxiliary power. XP≈5K
- The temperature sensor (T-probe) is located directly in the mixed water channel and regulates through injection of hot boiler water the set flow temperature.
- The circulation pump (2) sucks in the mixing water at the mixing machine and pushes with the same pressure onto the heating circuit as well as the boiler circuit.
- The safety temperature limiter (3) switches off when the set flow temperature is exceeded. Before installation apply the enclosed heat paste to the base of the valve and fasten it with the belt.

Parts of the mixing station

- Mixing machine (1) Fixed value controller
- Circulation pump (2) Wilo-Yonos Para RS 25/6 RKA
- Safety temperature limiter (3) Factory setting 55°C
- Ball valves 1 „(4), red = supply, blue = return

Planning / Sizing

The control station is designed for a heating capacity of min. 3 kW (volume flow $V \sim 0.2 \text{ m}^3$) up to max. 10 kW (maximum volume flow 1.3 m³ / h). (Max. Floor heating surface approx. 150 m²). The circulating pump Wilo-Yonos Para RS 25/6, RKA has a max. Delivery height (differential pressure) of 6 m, 60 kPa and a max. Volume flow of 3.3 m³ / h. The max. transferable heating power of the control station results from a normal underfloor heating circuit a pressure of ≈3.5 m, 35 kPa at a max. Volume flow of ≈1.3 m³ / h. This max. Values are within the characteristic field of the U-pump in operating mode $\Delta P = \text{Constant}$. Control knob should be adjusted to ≈ 3.5. (see Wilo publication)

Adjustment during commissioning

- Set the flow temperature of the mixing machine via the adjusting knob (1) (factory setting 45°C)
- Set each heating circuit to the calculated volume flow, e.g. 1l/min.
- Set the circulating pump to the determined delivery height ΔP - constant (for example 3 m, 30 kPa) or in such a way that all flow rate indicators show the required (previously calculated) flow rate; IMPORTANT: all heating circuits need to be open at the same time (first open function of the actuators).

Technical data constant control kit

Pressure	PN 10
Max. operating pressure	6 bar, 1 MPa
Max. differential pressure	0.8 bar, 8 kPa
Max. operating temperature	90°C
Content	Heating water VDI 2035
Connection	MT G 1"
Material	Brass DZR
KV Value	3.2 m ³ /h, 1 bar

Pump

Pump	Wilo-Yonos-Para-RKA
Voltage	230 V 50 Hz
Content	Heating water VDI 2035
Max. discharge head	6 mWs, 60 kPa
Max. volume flow	3.3 m ³ /h
Additional information	can be found in Wilo's publication

Contact thermostat AT 90

The AT 90 has a locking function with a locking disc against unconscious adjustment on the adjusting knob. For a faster heat transfer between the probe and the tube a heat paste should be applied.

Technical details & parts of the AT 90

Nominal voltage 250V / 380V	AT 90
Nominal current 15 (2,5) A / 10 (1,5) A	Adjustment range (°C): 20 to 90
Switching amount, 1 pole	Max. permissible sensor temperature (°C): 120
Protection class IP 40	Max. Ambient temperature (°C): -20 bis +60
Safety class 1	Time constant (sec): < 60
Test class II	Fixing with tensioning tube up to 2
Radio interference class N	
Cable glant PG II	Dimensions (mm): 100 x 40 x 3
Switching difference 4K	Heat paste 4 g
Temperature sensor: fluid	see enclosed document

ATTENTION!

For economic reasons, always use the standard constant control kit in combination with a terminal strip with integrated pump logic (Standard Plus), for economic reasons.

Electrical connection

Please connect the wires with:

- green/yellow with ground
- blue with Neutral
- brown with Phase

After connecting the constant control kit is automatically controlling the temperature of the underfloor heating system to the set temperature value.

Characteristics curve - Pump

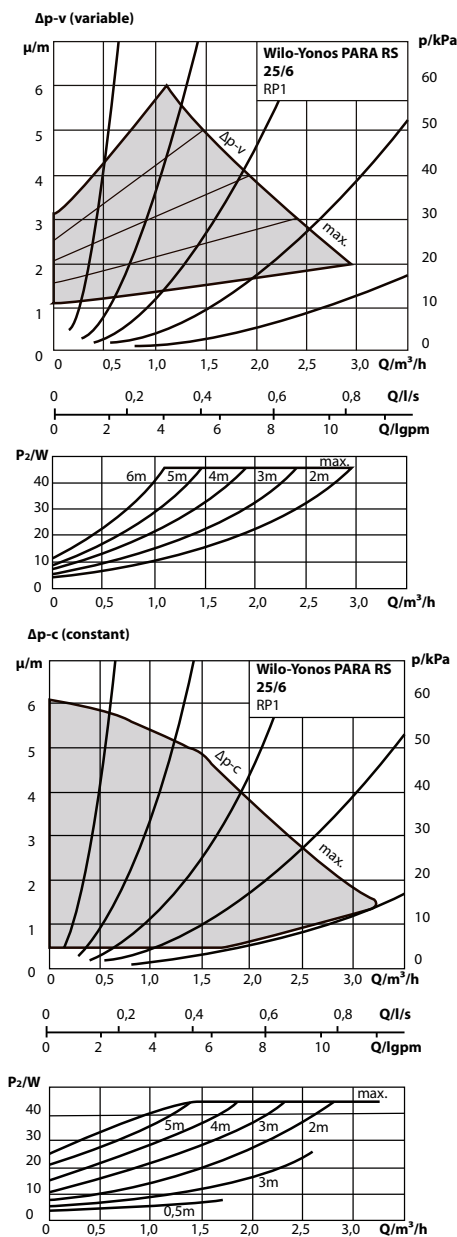

Characteristics curve - Control valve

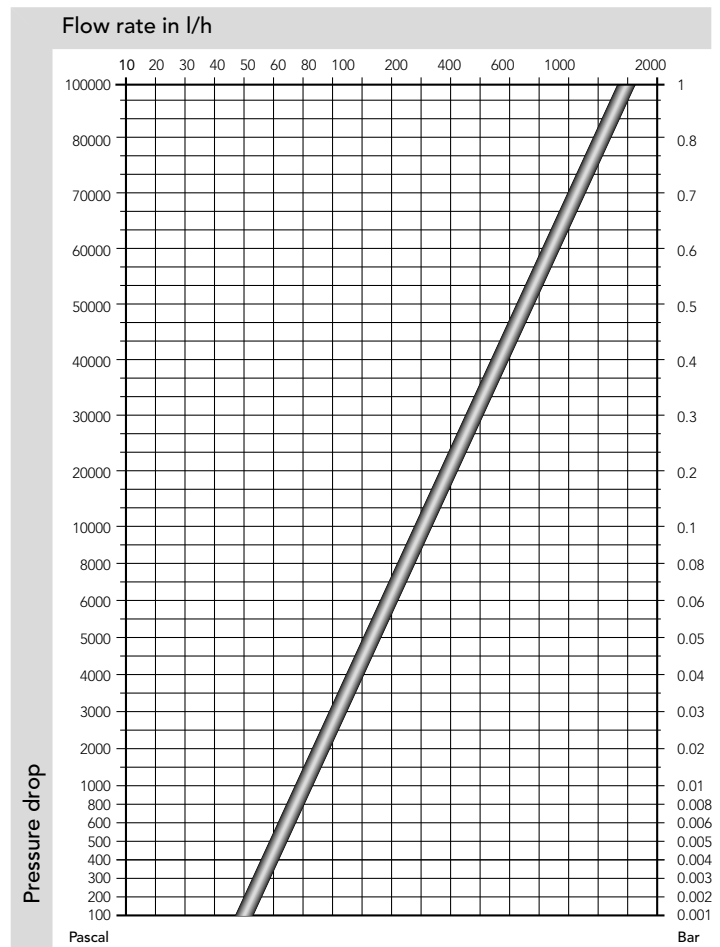

Attention:

The pump must be switched off via a terminal strip with pump logic when all actuators are closed.

5.5 Distribution cabinets

On-wall distribution cabinet

The MAINCOR on-wall distribution cabinet with removable door is made of electrogalvanised sheet steel. The mounting rails at the rear are used to support the heating manifold. The height adjustable cabinet feet provide stability for the manifold and also serve for levelling to the screed.



Use

The distribution cabinet is used in new and old buildings for safe and visually attractive accommodation of the heating manifold. The manifold is fixed to the floor and levelled with the feet. The upper third of the manifold should be fixed via the rear wall with screws.

Product data

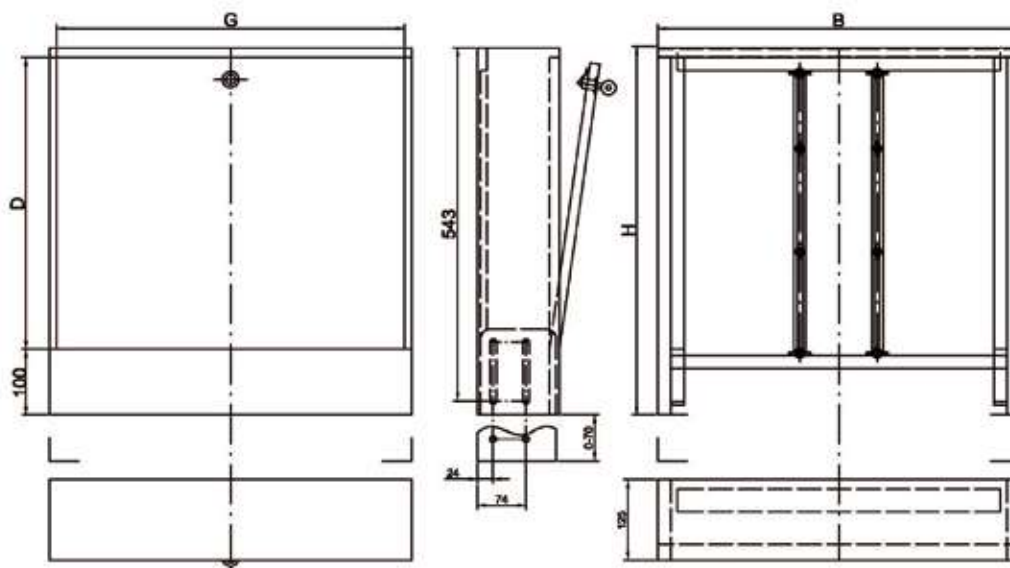

Designation	OW 5 3 - 5 circuits	OW 8 6 - 8 circuits	OW 11 9 - 11 circuits	OW 12 ab 12 circuits
Code	50.922.002	50.922.003	50.922.004	50.922.005
B (mm)	552	802	952	1.102
H (mm)	565-635	565-635	565-635	565-635
G (mm)	522	772	922	1.072
D (mm)	450	450	450	450

In-wall distribution cabinet

The MAINCOR in-wall manifold cabinet is made of electrogalvanised sheet steel with height adjustable installation frame. The mounting rails at the rear are used to support the heating manifold. The height adjustable cabinet feet provide stability for the manifold and also serve for levelling to the screed.



Use

The manifold cabinet is used in new and old buildings for safe and visually attractive accommodation of the heating manifold. The manifold is fixed to the floor and levelled with the feet (70 mm height, 110 - 140 mm or 80 mm depth). The upper third of the manifold should be fixed via the rear wall with screws.

Product data

Designation	IW 5 2 - 4 circuits	IW 8 5 - 9 circuits	IW 11 10 - 12 circuits	IW 12 13 - 14 circuits	IW 16 15 - 17 circuits
Code	50.911.002 50.933.002	50.911.003 50.933.003	50.911.004 50.933.004	50.911.005 50.933.005	50.911.006 50.933.006
A (mm)	513	748	898	1.048	1.198
B (mm)	441	676	826	976	1.126
C (mm)	449	684	834	984	1.134
D (mm)	489	724	874	1.024	1.174

At the variant with integrated DIN rail (50911013 - 50911015) the installation height increases 130mm to 846mm (+max.180mm). The DIN rail is for mounting the terminal strip with a distance of 85mm from the top edge.

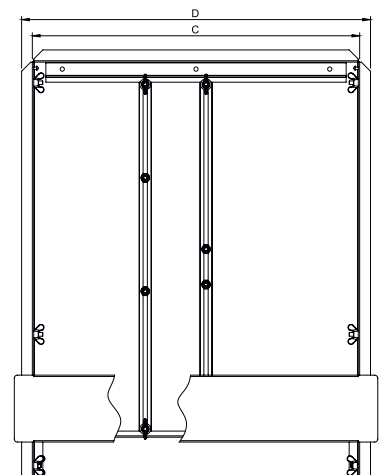
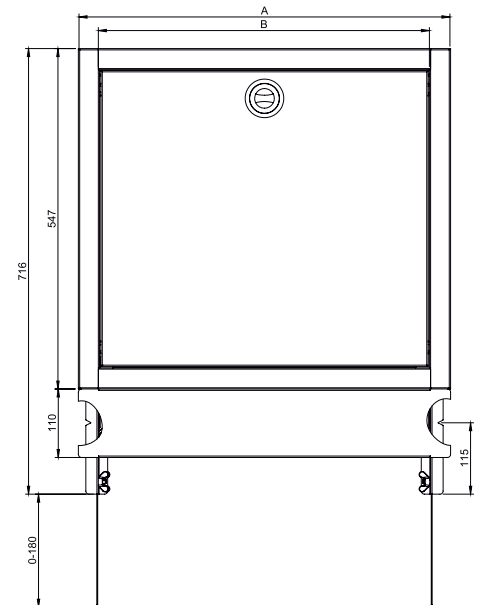

The following table enables you to determine the distribution cabinet sizes in conjunction with the required manifold 1 ¼" or 1" and accessories like ball valve, connection group heat flow meter or constant control kit.

Manifold 1 ¼"	+ Ball valve	+ Heat flow meter connection kit vertical	+ Heat flow meter connection kit horizontal	+ Constant control kit	+ Heat flow meter connection kit vertical	+ Constant control kit	+ Heat flow meter connection kit horizontal	+ Constant control kit
2 Circuits	OW5 / IW5*	OW5 / IW5*	OW5 / IW8*	OW5 / IW8*	OW8 / IW8*		OW8 / IW11*	
3 Circuits	OW5 / IW5*	OW5 / IW5*	OW8 / IW8*	OW5 / IW8*	OW8 / IW8*		OW8 / IW11*	
4 Circuits	OW5 / IW5*	OW5 / IW8*	OW8 / IW8*	OW8 / IW8*	OW8 / IW11*		OW11 / IW11*	
5 Circuits	OW5 / IW8*	OW5 / IW8*	OW8 / IW8*	OW8 / IW8*	OW8 / IW11*		OW11 / IW12*	
6 Circuits	OW5 / IW8*	OW8 / IW8*	OW8 / IW11*	OW8 / IW8*	OW8 / IW11*		OW11 / IW12*	
7 Circuits	OW8 / IW8*	OW8 / IW8*	OW8 / IW11*	OW8 / IW11*	OW11 / IW12*		OW12 / IW12*	
8 Circuits	OW8 / IW8*	OW8 / IW11*	OW11 / IW11*	OW8 / IW11*	OW11 / IW12*		OW12 / IW16*	
9 Circuits	OW8 / IW8*	OW8 / IW11*	OW11 / IW12*	OW11 / IW11*	OW11 / IW12*		OW12 / IW16*	
10 Circuits	OW8 / IW11*	OW8 / IW11*	OW11 / IW12*	OW11 / IW12*	OW12 / IW16*		np* / IW16*	
11 Circuits	OW8 / IW11*	OW11 / IW12*	OW12 / IW12*	OW11 / IW12*	OW12 / IW16*		np* / np*	
12 Circuits	OW11 / IW11*	OW11 / IW12*	OW12 / IW16*	OW12 / IW12*	OW12 / IW16*		np* / np*	
13 Circuits	OW11 / IW12*	OW11 / IW12*	OW12 / IW16*	OW12 / IW16*	np* / IW16*		np* / np*	
14 Circuits	OW11 / IW12*	OW12 / IW16*	np* / IW16*	OW12 / IW16*	np* / np*		np* / np*	
15 Circuits	OW12 / IW12*	OW12 / IW16*	np* / np*	OW12 / IW16*	np* / np*		np* / np*	
16 Circuits	OW12 / IW16*	OW12 / IW16*	np* / np*	np* / np*	np* / np*		np* / np*	

Manifold 1"	+ Ball valve	+ Heat flow meter connection kit vertical	+ Heat flow meter connection kit horizontal	+ Constant control kit	+ Heat flow meter connection kit vertical	+ Constant control kit	+ Heat flow meter connection kit horizontal	+ Constant control kit
2 Circuits	OW5 / IW5*	OW5 / IW5*	OW5 / IW8*	OW5 / IW8*	OW8 / IW8*		OW8 / IW11*	
3 Circuits	OW5 / IW5*	OW5 / IW8*	OW8 / IW8*	OW5 / IW8*	OW8 / IW8*		OW11 / IW11*	
4 Circuits	OW5 / IW5*	OW5 / IW8*	OW8 / IW8*	OW8 / IW8*	OW8 / IW11*		OW11 / IW12*	
5 Circuits	OW5 / IW8*	OW8 / IW8*	OW8 / IW11*	OW8 / IW8*	OW8 / IW11*		OW11 / IW12*	
6 Circuits	OW5 / IW8*	OW8 / IW8*	OW8 / IW11*	OW8 / IW11*	OW11 / IW11*		OW12 / IW16*	
7 Circuits	OW8 / IW8*	OW8 / IW8*	OW8 / IW11*	OW8 / IW11*	OW11 / IW12*		OW12 / IW16*	
8 Circuits	OW8 / IW8*	OW8 / IW11*	OW11 / IW12*	OW8 / IW11*	OW11 / IW12*		OW12 / IW16*	
9 Circuits	OW8 / IW11*	OW8 / IW11*	OW11 / IW12*	OW11 / IW12*	OW12 / IW12*		OW12 / IW16*	
10 Circuits	OW8 / IW11*	OW11 / IW11*	OW11 / IW12*	OW11 / IW12*	OW12 / IW16*		np* / np*	
11 Circuits	OW11 / IW11*	OW11 / IW12*	OW12 / IW16*	OW11 / IW12*	OW12 / IW16*		np* / np*	
12 Circuits	OW11 / IW12*	OW11 / IW12*	OW12 / IW16*	OW12 / IW16*	np* / IW16*		np* / np*	
13 Circuits	OW11 / IW12*	OW12 / IW12*	OW12 / IW16*	OW12 / IW16*	np* / np*		np* / np*	
14 Circuits	OW11 / IW12*	OW12 / IW16*	np* / np*	OW12 / IW16*	np* / np*		np* / np*	
15 Circuits	OW12 / IW16*	OW12 / IW16*	np* / np*	np* / IW16*	np* / np*		np* / np*	

OW= Distribution cabinet, on-wall

IW= Distribution cabinet, in-wall

np = not possible

*the distribution cabinet in wall 80 mm are the same like the standard 110 mm.

5.6 Screed additive

To increase the screed density and improve the flexural and compressive strength, an additive must be used in order to establish a heating screed. Using this additive makes the screed easier to process, as the plastification is increased and less water is required.

Use

Standard screed mixers are used for mixing the screed mortar. Once the first sand has been placed in the machine, add MAINCOR screed additive followed by the binder and water; then add the remaining sand. Mixing time minimum 3 minutes! Ensure or adjust to an earth-moist to stiff-plastic consistency. Apply the screed mortar in the usual way, compact, level and smooth. Smoothing with a machine is recommended. The curing screed must be protected from direct sunlight and draught (for calcium sulphate screeds min. 48 hours, cement screed min. 72 hours) The usual DIN/EN specifications and applicable ZDB notices must be observed.

Designation	Screed additive, normal	Screed additive, low
Article	50.903.123	50.903.223
Basis	Powder	Powder
Density	0.77 kg/l	1.16 kg/l
Material consumption	about 0.4% of binder weight	about 0,4% of binder weight
Processing time	about 120 min at +20 °C	about 120 min at +20 °C
Packaging	10 kg bag	13 kg bag
Storage	12 months, dry	6 months, dry
Min. thickness	45 mm	35 mm
Yield	145 m ² at 65 mm	270 m ² at 45 mm

All specified values are approximate.
These depend on both the binder and the site conditions.

Important information

The production of screed mortar must take place in compliance with the generally recognised building regulations and our processing guidelines as well as the requirements of DIN 18560 „Floor screeds in building construction“ and DIN EN 13813 „Screed material“. Nominal screed thicknesses must comply with the requirements of DIN 18560 „Floor screeds in building construction“ and DIN 18202 „Tolerances in building construction“. Higher nominal screed thicknesses can negatively influence the drying behaviour. The aggregate must be a sand of the particle size group 0/8 according to EN 13139. Fines ≤ 0.063 mm category 1 of maximum 3%. The grading curve should be constant between A8 and B8. This ensures the best results in terms of drying and strength. The use of an excessive amount of sand or sand that is too fine as well as too much water delays drying and reduces the screed strength. Any sedimentation layers and/or sinter layers must be removed with suitable abrasive material so that the drying phase is not hindered. For cement screeds, all test certificates are based on the use of CEM I cements. Other additives must not be used.

6. Performance tables

- according to DIN EN 1264

The following tables show the heat flow density depending on the laying distance and flow temperature using different types of floor coverings. The specified heat outputs are valid for the following systems:

- Stapler system
- Pipe positioning panel system
- Rail system

The heat output tables for our dry construction systems are also contained in the respective sections.

Flow 40°C / Return 30°C

Room temperature θ_r [°C]	Heat output q [W/m ²]										Floor covering [m ² K/W]
	Laying distance of heating pipes [mm]										
	300	250	225	200	175	150	125	100	75	50	
15	72	82	88	95	102	110	118	127	137	147	$R_\lambda = 0.00$ m ² K/W without covering
18	61	69	74	80	86	92	99	107	115	124	
20	53	61	65	70	75	81	87	93	101	108	
22	45	52	56	60	64	69	74	80	86	93	
24	37	43	46	50	53	57	61	66	71	77	
15	58	65	69	73	78	82	88	93	99	105	$R_\lambda = 0.05$ m ² K/W Tiles
18	49	55	58	61	65	69	74	78	83	89	
20	43	48	51	54	57	61	64	69	73	78	
22	36	41	43	46	49	52	55	59	62	66	
24	30	34	36	38	40	43	46	48	51	55	
15	49	54	57	60	63	66	70	73	78	82	$R_\lambda = 0.10$ m ² K/W Carpet
18	41	46	48	51	53	56	59	62	65	69	
20	36	40	42	44	46	49	51	54	57	60	
22	31	34	36	38	40	42	44	46	49	51	
24	26	28	30	31	33	35	36	38	40	43	
15	43	47	49	51	53	56	58	61	64	67	$R_\lambda = 0.15$ m ² K/W Parquet
18	36	39	41	43	45	47	49	51	54	56	
20	32	34	36	38	39	41	43	45	47	49	
22	27	29	31	32	34	35	37	38	40	42	
24	22	24	25	27	28	29	30	32	33	35	

Heat outputs that exceed the maximum surface temperature for occupied zones of 29°C are shown in red.

When the fields are not filled with values the surface temperature exceeds 35°C and therefore it is not allowed in accordance with DIN EN 1264.

Flow 45°C / Return 35°C

Room temperature θ_i [°C]	Heat output q [W/m ²]										Floor covering [m ² K/W]
	Laying distance of heating pipes [mm]										
	300	250	225	200	175	150	125	100	75	50	
15	91	104	111	120	129	138	148	160	172	185	$R_f = 0.00$ m ² K/W without covering
18	79	91	97	105	113	121	130	140	151	163	
20	72	82	88	95	102	110	118	127	137	147	
22	64	74	79	85	91	98	105	113	123	132	
24	57	65	70	75	81	87	93	100	108	116	
15	73	82	87	92	98	104	110	117	125	133	$R_f = 0.05$ m ² K/W Tiles
18	64	72	76	80	86	91	97	103	109	116	
20	58	65	69	73	78	82	88	93	99	105	
22	52	58	62	65	69	74	78	83	89	94	
24	46	51	54	58	61	65	69	73	78	83	
15	62	68	72	76	79	84	88	92	98	103	$R_f = 0.10$ m ² K/W Carpet
18	54	60	63	66	70	73	77	81	86	90	
20	49	54	57	60	63	66	70	73	78	82	
22	44	49	51	54	56	59	62	66	69	73	
24	39	43	45	47	50	52	55	58	61	64	
15	54	59	61	64	67	70	73	77	80	84	$R_f = 0.15$ m ² K/W Parquet
18	47	52	54	56	59	62	64	67	70	73	
20	43	47	49	51	53	56	58	61	64	67	
22	38	42	44	46	48	50	52	55	57	60	
24	34	37	39	40	42	44	46	48	50	53	

Flow 50°C / Return 40°C

Room temperature θ_i [°C]	Heat output q [W/m ²]										Floor covering [m ² K/W]
	Laying distance of heating pipes [mm]										
	300	250	225	200	175	150	125	100	75	50	
15	109	125	134	144	155	166	179	192	208	223	$R_x = 0.00$ m ² K/W without covering
18	98	112	120	130	139	149	160	173	187		
20	91	104	111	120	129	138	148	160			
22	83	95	102	110	118	127	136				
24	76	87	93	100	108	115					
15	88	98	105	111	118	125	133	141	150	160	$R_x = 0.05$ m ² K/W Tiles
18	79	88	94	99	106	112	119	127	135	144	
20	73	82	87	92	98	104	110	117	125	133	
22	67	75	80	84	90	95	101	108	114	122	
24	61	68	73	77	82	87	92	98	104	111	
15	75	82	86	91	96	101	106	111	118	124	$R_x = 0.10$ m ² K/W Carpet
18	67	74	78	82	86	90	95	100	106	111	
20	62	68	72	76	79	84	88	92	98	103	
22	57	63	66	69	73	77	81	85	90	94	
24	52	57	60	63	66	70	73	77	82	86	
15	65	71	74	78	81	85	89	92	97	101	$R_x = 0.15$ m ² K/W Parquet
18	58	64	66	70	73	76	80	83	87	91	
20	54	59	61	64	67	70	73	77	80	84	
22	50	54	56	59	62	65	67	70	74	77	
24	45	49	51	54	56	59	61	64	67	70	

7. Standards

Applicable standards and directives for underfloor heating installation are shown in the following table. Only the most important reference DIN standards, requirements, regulations and ordinances are listed.

Standards and directives	Meaning
a.R.d.T.	Recognised technical rules
EnEV	Energy Saving Ordinance 2014
ETB	Introduced Technical Building Regulations
Heating costs V	Ordinance on the calculation of heating costs
VOB/B and C	General conditions of contract relating to the execution of construction work, DIN 1961
DIN 1055	Design loads for buildings
DIN 18195	Water-proofing of buildings
DIN 18202	Tolerances in building construction
DIN 18336	German construction contract procedures (VOB); Part C (ATV); Waterproofing
DIN 18352	German construction contract procedures (VOB); Part C (ATV); Wall and floor tiling
DIN 18353	German construction contract procedures (VOB); Part C (ATV); Laying of floor screed
DIN 18356	Laying of parquet flooring
DIN 18560	Floor screeds in building construction
DIN 4102	Fire behaviour of building materials and building components
DIN 4108	Thermal insulation and energy economy in buildings
DIN 4109	Sound insulation in buildings
DIN 4701	Heat demand of buildings
DIN EN 12831	Method for calculation of the design heat load
DIN EN 832	Thermal performance of buildings - Calculation of energy use for heating
DIN EN 1264	Underfloor heating, systems and components
DIN EN 13162	Thermal insulation products for buildings - Factory made mineral wool (MW) products
DIN EN 13163	Thermal insulation products for buildings - Factory made expanded polystyrene (EPS) products
DIN EN 13164	Thermal insulation products for buildings - Factory made extruded polystyrene foam (XPS) products
DIN EN 13165	Thermal insulation products for buildings - Factory made rigid polyurethane foam (PU) products
DIN EN 13166	Thermal insulation products for buildings - Factory made phenolic foam (PF) products
DIN EN 13167	Thermal insulation products for buildings - Factory made cellular glass (CG) products
DIN EN 13168	Thermal insulation products for buildings - Factory made wood wool (WW) products
DIN EN 13169	Thermal insulation products for buildings - Factory made expanded perlite board (EPB) products
DIN EN 13170	Thermal insulation products for buildings - Factory made products of expanded cork (ICB)
DIN EN 13171	Thermal insulation products for buildings - Factory made wood fibre (WF) products
DIN V 4108-10	Thermal insulation and energy economy in buildings - Application-related requirements for thermal insulation materials
DIN V 4108-6	Thermal insulation and energy economy in buildings - Calculation of annual heat and energy use
DIN V 4701-10	Energy efficiency of heating and ventilation systems in buildings - Heating, domestic hot water supply, ventilation
DIN 16833	Polyethylene pipes of raised temperature resistance (PE-RT) - PE-RT type I and PE-RT type II
ISO 21003	Multilayer piping systems for hot and cold water installations inside buildings
DIN EN 22391	Plastic piping systems for hot and cold water installations - Polyethylene of raised temperature resistance (PE-RT)
ISO 10508	Plastic piping systems for hot and cold water installations - Guidance for classification and design
DIN 16839	Pipes of crosslinked high density polyethylene (PE-X)
DIN 4726	Warm water surface heating systems and radiator connecting systems - Plastic piping systems and multilayer piping systems
DIN EN ISO 15875	Plastic piping systems for hot and cold water installation - Crosslinked polyethylene (PE-X)

8. Certificates



CERTIFICATE

Extended Warranty

We herewith confirm the extension of the warranty for pipe products for the underfloor heating system MAINFLOOR (incl. the new velcro system):

PE-RT pipe (oxygen-tight because of EVOH layer):

10x1,3; 14x1,5; 14x2,0; 16x1,5; 16x2,0; 17x2,0; 18x2,0; 20x2,0 and 25x2,3

Composite pipe PE-RT/Aluminium/PE-RT: 16x2,0

For a period of **10 years**, we will provide replacement for:

- 1) MAINFLOOR pipe systems in the event of damage that is demonstrably due to defects in production or material.
- 2) Damage that is caused by production defects to the property of third parties and any resulting consequential losses.
- 3) Expenses of third parties caused by removing, dismantling, disassembly and clearing of defective products as well as for mounting and laying non-defective products to be supplied by us.

The warranty extends to all above mentioned system components such as pipes and fittings insofar as supplied by us. No warranty is granted for laying and installation errors. The technical documentation and application guidelines shall be decisive. For coverage, there is an extended product liability insurance with a renowned German insurance company with the following sums insured:

3.000.000,- EUR lump-sum, for bodily injury as well as economic losses of property and product

2.000.000,- EUR maximum sum for an individual person

Schweinfurt, December 1, 2021



Dieter Pfister
Managing director



Michael Pfister
Managing director

ZERTIFIKAT



SKZ - Testing GmbH awards the following company

Maincor Rohrsysteme GmbH & Co. KG
Silbersteinstraße 14
97424 Schweinfurt
Deutschland

Production site: Maincor Rohrsysteme GmbH & Co. KG., 97478 Knetzgau, Germany
the right to use the **SKZ** testing and inspection mark



A 522

for the following plastic products

Heating pipes made of polyethylene PE-RT type I and type II
1-, 3- and 5-layer wall structure

Trade name: MAINFLOOR

SKZ specification for tests and inspection **HR 3.16:2015-04**
in conjunction with **DIN EN ISO 22391-2**

Users of the **SKZ** mark are obliged to observe the required regulations for the production and testing of these products.

Date of initial certification: 24 April 2014

Date of expiry: 9 April 2024

Würzburg, 10 April 2019



i.V. 
Dipl.-Ing. Hans-Peter Krause
Head of Certification Body

The original language of this certificate is German. In case of doubt, the German version is obligatory.

SKZ - Testing GmbH, Friedrich-Bergius-Ring 22, 97076 Würzburg, Germany. Tel. +49 931 4104-0, testing@skz.de, www.skz.de

ZERTIFIKAT



SKZ - Testing GmbH awards the following company

MAINCOR Rohrsysteme GmbH & Co. KG
Silbersteinstraße 14
97424 Schweinfurt
Germany

Production site: MAINCOR Rohrsysteme GmbH & Co. KG, 97478 Knetzgau, Germany

the right to use the **SKZ** testing and inspection mark



A 462

for the following plastic products

Heating pipes made of polyethylene PE-RT type II/Al/PE-RT type II
1-, 3- and 5-layer wall structure

Trade name: *Mainpipe*

SKZ specification for tests and inspection **HR 3.12:2015-06**

Users of the **SKZ** mark are obliged to observe the required regulations for the production and testing of these products.

Date of initial certification: 15 October 2015

Date of expiry: 19 May 2024

Würzburg, 20 May 2019



i.V.

Hans-Peter Krause
Dipl.-Ing. Hans-Peter Krause
Head of Certification Body

The original language of this certificate is German. In case of doubt, the German version is obligatory.

SKZ - Testing GmbH, Friedrich-Bergius-Ring 22, 97076 Würzburg, Germany, Tel. +49 931 4104-0, testing@skz.de, www.skz.de



Certificate

KOMO[®]

technical approval-with-product certificate



Number	K77485/02	Replaces	K77485/01
Issued	2014-01-01	Dated	2013-04-01
Valid until	Indefinite	Page	1 of 3

Mainfloor piping system for underfloor heating systems

MAINCOR Rohrsysteme GmbH & Co. KG

STATEMENT BY KIWA

This product certificate is issued by Kiwa on the basis of BRL 5602 "Plastic piping systems of PE-RT intended for underfloor heating" issued on 1 June 2008 by Kiwa, in accordance with the Kiwa regulations for product certification.

Kiwa declares that legitimate confidence exists that:

- the by the producer manufactured products comply with the technical specifications as laid down in this technical approval-with-product certificate provided that they have been marked with the KOMO[®]-mark in the manner as indicated in this technical approval-with-product certificate;
- the with certified products composed Mainfloor piping system provides the performances as described in the technical approval-with-product certificate, provided that:
 - the manufacturing of the Mainfloor piping system intended for heating systems takes place according to the processing methods as laid down in this technical approval-with-product certificate;
 - the application conditions as described in this approval-with-product certificate are met.

Within the framework of this technical approval-with-product certificate Kiwa does not impose any inspections with regard to the production of other parts of the Mainfloor piping system, nor the manufacturing of the Mainfloor piping system itself.

Bouke Meekma
Kiwa

The certificate is listed in the overview on the website of Stichting KOMO: www.komo.nl.
Advice: consult www.kiwa.nl in order to ensure that this certificate is still valid.

Kiwa Nederland B.V.
Sir Winston Churchillaan 273
Postbus 70
2280 AB RIJSWIJK
The Netherlands

Tel. +31 70 414 44 00
Fax +31 70 414 44 20
info@kiwa.nl
www.kiwa.nl

Holder of Certificate
MAINCOR Rohrsysteme GmbH & Co. KG
Silbersteinstraße 14
97424 SCHWEINFURT
Germany
T +49 (0)97 21 / 65977 - 100
F +49 (0)97 21 / 65977 - 200
E info@maincor.de
I www.maincor.de

Production location
MAINCOR Rohrsysteme GmbH & Co. KG
Maincor 1
97478 KNETZGAU
Germany



Evaluated is:
Quality system
Product in application
Periodic inspection

Template for pressure test

Pressure test report according to DIN 18380 for heating pipes

Construction project:

.....
.....
.....

Construction phase:

.....
.....

Tester / Company:

.....
.....

System heightm

Flow temperature design parameters °C Return temperature °C

Start:.....(date, time) Test pressure:..... bar (min. 5 bar, max. 6 bar)

End:(date, time) Pressure drop: bar (max. 0.2 bar)

max. permissible operating pressure (based on lowest point of the system) bar

Nominal diameters used.....

The aforementioned system was heated on
to the design temperature and no leaks were detected. After cooling, no leaks were detected.

A visual inspection of the joints was carried out: yes/no

Antifreeze was added to the water: yes/no

Sequence as stated above: yes/no

CERTIFICATION:

..... (Place, Date) (Stamp, Signature, Contractor)

..... (Place, Date) (Stamp, Signature, Contractor)

Radiant heating construction requirements

CUSTOMER ADDRESS:

Company: _____
Name: _____
Street: _____
Postcode, Town: _____
Tel: _____
ADM MAINCOR: _____
Date: _____

BUILDING-SPECIFIC INFORMATION:

Type: New building Old building Industrial building Other

The following information must also be provided:

1. Construction plan as a drawing printout or file (dxf, dwg, tiff, pdf, ...)
2. Calculation of thermal insulation EnEV, heating load (if available)
3. Information on influencing factors such as ventilation systems, additional heating systems
4. Rooms with FBH must be marked in the construction drawing

SYSTEM-SPECIFIC INFORMATION:

Wet-system

- Staple Rails Pipe positioning panel
Screed: Cement/Anhydrite Floating screed
Top layer: Tiles PVC Parquet Carpet

Dry-system

- EPS Eco
Top layer: Fermacell Parquet Screed brick Load distribution plate
 Strongboard

Wall heating

- Dry system Rail system

Type of insulation: _____
Flow temperature: _____ °C
Type of pipe: _____
Control method: _____
Manifold: In-wall On-wall

CALCULATION METHOD:

- Detailed calculation method (U values/heat demand of customer/according to DIN)
 Simplified calculation method with assumed heat demand

Where there is no calculation information, standard values according to DIN are assumed.
Design takes place according to DIN EN 1264.

Tick if applicable and complete and send with documents to the following address:
MAINCOR Rohrsysteme GmbH & Co. KG, Silbersteinstraße 14, 97424 Schweinfurt, Fax: +49 9721 65977 678



GERMANY

Hotline: +49 9721 659 77-500

Fax: +49 9721 659 77-600

Website: www.maincor.de

E-Mail: info@maincor.de

MAINCOR Rohrsysteme GmbH & Co. KG

Silbersteinstraße 14

97424 Schweinfurt